

linear shower drains and systems for bathrooms

Profilpas offers a wide range of solutions for bathrooms which combine functionality and modern design. In particular, Profilpas bathroom systems allow the creation of floor-level showers, with a wide selection of linear shower drains - like PP Drain Aqua, Thin Drain, Slim Drain and Smart Drain, all customizable with different grates - and Q-Drain, available in several models. Profilpas bathroom range also includes Glass Profile, a line of profiles for the insertion of glass walls and the finishing of the shower surface, designed to compensate the 2% slope.



PP Drain Aqua

PPdrain | Aqua

The linear shower drains PP Drain Aqua, made of stainless steel AISI 316 and provided with a patented removable siphon in antibacterial ABS, are a perfect synthesis of beauty and practicality. Profilpas has taken care of every aspect of their design, production and quality control, to offer a product that is always efficient and aesthetically perfect.

The linear shower drains PP Drain Aqua, composed of a single piece without welds, distinguish for their design and functionality that make them elegant, simple to install and easy to clean. Each part of the shower drain is studied in detail, to contain in few components all that is needed to guarantee the maximum ease of installation and maintenance.

Aesthetics



Elegant and exclusive design, customisable with a wide range of covers and finishes.

Removable siphon

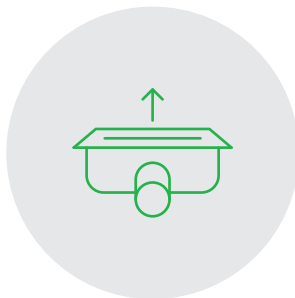

The siphon is simple to remove and can be easily inspected, for the maximum efficiency.

Ease of installation



The assembly and the adjustment of the shower drain are simplified, for a simple and quick installation.

Cleanliness and hygiene



The removable siphon in antibacterial ABS simplifies the maintenance and allows a quick and efficient cleanliness.



PP Drain Aqua

The essentiality of the linear shape of the shower drain, combined to the beauty of the multiple finishes, allows to offer an aesthetically perfect solution, able to adapt to any kind of design and to any material (porcelain stoneware, marble, mosaic, natural stone...).

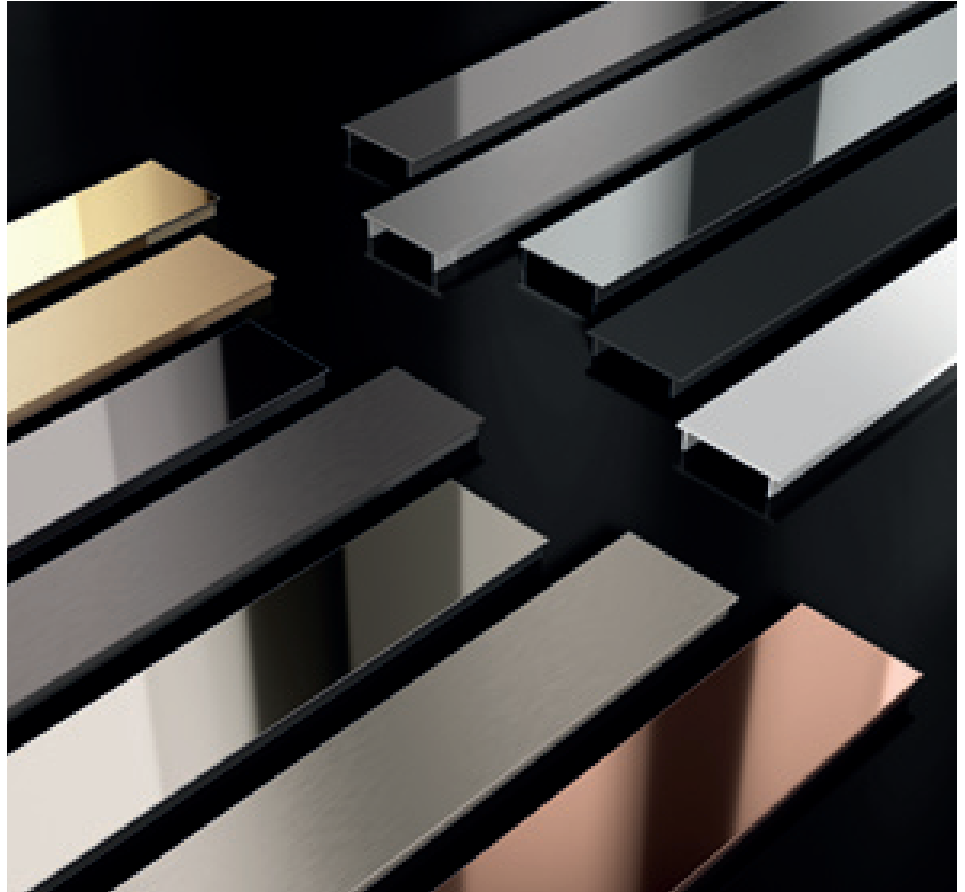

PP Drain Aqua

With PP Drain Aqua linear shower drains, maintenance and cleaning are fully simplified. The siphon, made of antibacterial ABS, can be removed and inspected completely. Furthermore, the AISI 316 stainless steel shower drain base is composed of a single piece without welds and sharp edges for the best hygiene and efficiency. Studied to minimize installation times, they are equipped with a pre-glued waterproofing membrane, supports from 6 to 18 mm for the height adjustment of the covers and bases in polystyrene foam.



PP Drain Aqua

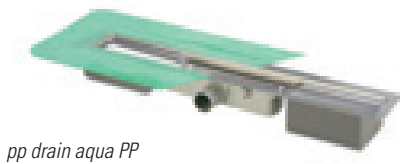

pp drain aqua PP

NEW PP DRAIN AQUA - shower drain base with siphon

ART.	finishing		L					
			60 cm	70 cm	80 cm	90 cm	100 cm	120 cm
STAINLESS STEEL								
PP/	stainless steel		22100	22101	22102	22103	22104	22105
	AISI 316 DIN 1.4404							
	euro/pc		150,92	158,40	171,05	178,53	189,09	204,05

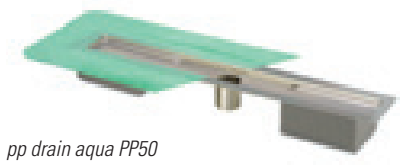

pp drain aqua PP50

NEW PP DRAIN AQUA - shower drain base with direct drainage diam. 50 mm

ART.	finishing		L					
			60 cm	70 cm	80 cm	90 cm	100 cm	120 cm
STAINLESS STEEL								
PP50/	stainless steel		22106	22107	22108	22109	22110	22111
	AISI 316 DIN 1.4404							
	euro/pc		115,17	122,54	135,30	142,67	153,34	168,30

Shower drain base with direct drainage diam. 40 mm available upon request.

cover¹

frame²

ABS supports

hair catcher filter

removable top in antibacterial ABS

removable siphon in antibacterial ABS

waterproofing membrane

single-piece base in stainless steel AISI 316

base in polystyrene

drain in antibacterial ABS

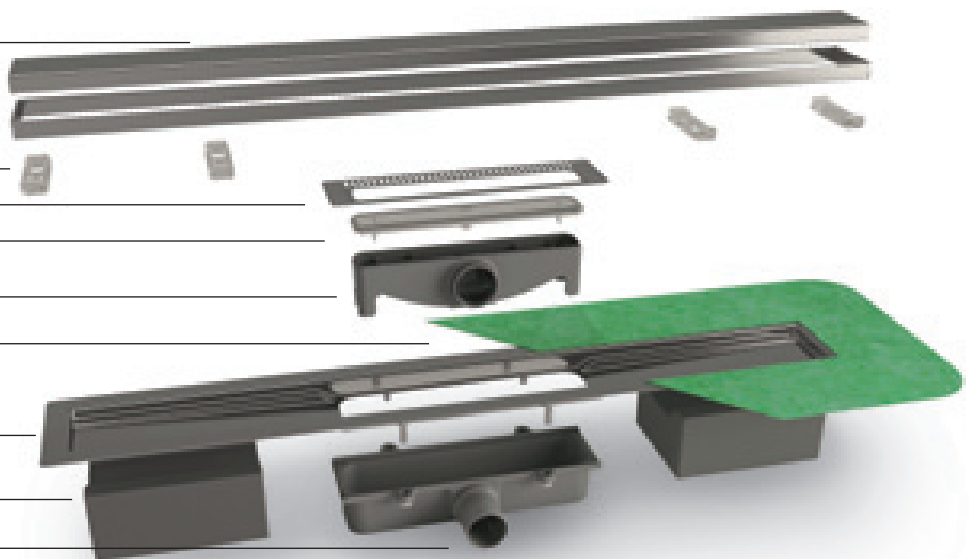

¹ Different types of cover available.

² The frame is present in Classic Cover model. The other covers are not equipped with frame.

Complete the article code with L measure (for example PP/ for L = 70 becomes PP/70)

Classic Cover, in polished or satin stainless steel AISI 316, is available in different lengths (from 60 to 120 cm). It includes the frame and the adjustment supports from 6 to 18 mm, and it is reversible: if turned upside down, it becomes tileable (up to 12 mm), thus creating aesthetic continuity with the bathroom covering.



PP Drain Aqua - Classic Cover polished stainless steel AISI 316 - DIN 1.4404

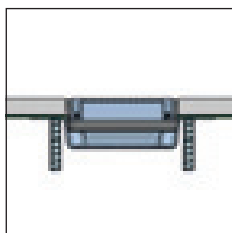

Classic Cover

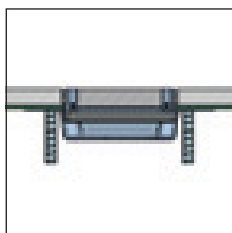

Classic Cover tileable



Classic Cover satin stainless steel AISI 316 DIN 1.4404



pp drain aqua RF

NEW CLASSIC COVER - tiles thickness from 6 to 18 mm

		L						
ART.	finishing	60 cm	70 cm	80 cm	90 cm	100 cm	120 cm	
STAINLESS STEEL								
XPC/	polished stainless steel AISI 316 DIN 1.4404		22112	22113	22114	22115	22116	22117
	satin stainless steel AISI 316 DIN 1.4404		22118	22119	22120	22121	22122	22123
	euro/pc		91,08	98,89	108,35	127,05	134,20	150,15

Classic Cover is reversible, if turned upside down it becomes tileable (with a thickness up to 12 mm).

NEW PP DRAIN AQUA RF - shower drain base with siphon and reversible cover for resin floors

		L			
ART.	finishing	60 cm	70 cm	80 cm	
STAINLESS STEEL					
PPRF/	stainless steel AISI 316 DIN 1.4404		22170	22171	22172
	euro/pc				

Complete the article code with L measure (for example XPC/ for L = 70 becomes XPC/70)

PP Drain Aqua

Flat Cover, available in several finishes and different lengths (from 60 to 120 cm), stands out for the perfectly flat and linear design. It is provided with adjustment supports that allow it to be adapted to tiles with thickness from 6 to 18 mm.

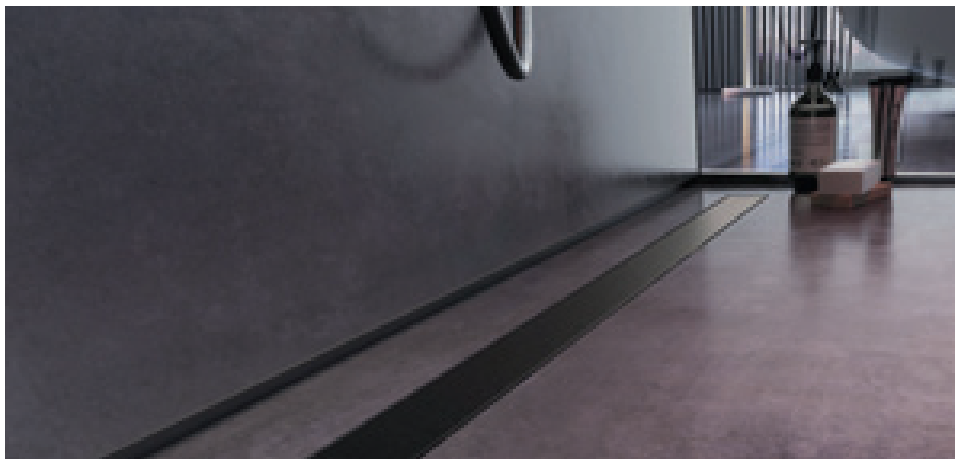

PP Drain Aqua - Flat Cover matt black colour-coated aluminium

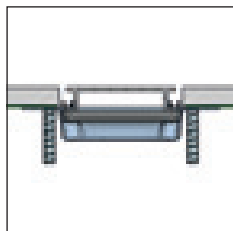

Flat Cover aluminium

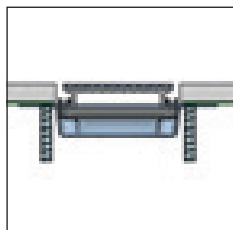

Flat Cover aluminium + stainless steel

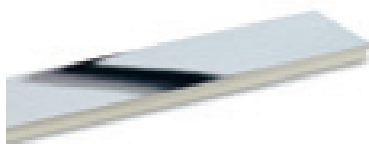

Flat Cover chromium-plated stainless steel

NEW FLAT COVER - tiles thickness from 6 to 18 mm

ART.	finishing		L					
			60 cm	70 cm	80 cm	90 cm	100 cm	
ALUMINIUM + STAINLESS STEEL								
XPF/	polished stainless steel AISI 316 DIN 1.4404		22136	22137	22138	22139	22140	22141
	satin stainless steel AISI 316 DIN 1.4404		22142	22143	22144	22145	22146	22147
	euro/pc		57,97	63,36	69,41	82,39	90,09	101,31
ALUMINIUM + CHROMIUM-PLATED STAINLESS STEEL								
XPF/	chromium-plated stainless steel AISI 316 DIN 1.4404		22261	22262	22263	22264	22265	-
	euro/pc		90,64	96,03	112,97	125,95	125,95	-
COLOUR-COATED ALUMINIUM								
XPF/	matt white		22148	22149	22150	22151	22152	-
	matt black		22154	22155	22156	22157	22158	-
	euro/pc		49,39	51,48	53,57	62,37	64,57	-
ALUMINIUM + STAINLESS STEEL								
XPF/	polished nickel		22226	22227	22228	22229	22230	-
	satin nickel		22231	22232	22233	22234	22235	-
	polished pink gold		22236	22237	22238	22239	22240	-
	euro/pc		161,48	166,76	172,81	185,90	193,49	-
	polished graphite		22241	22242	22243	22244	22245	-
	satin graphite		22246	22247	22248	22249	22250	-
	euro/pc		172,37	177,65	183,70	196,79	204,38	-
	polished gold		22251	22252	22253	22254	22255	-
	satin gold		22256	22257	22258	22259	22260	-
	euro/pc		253,99	259,38	265,43	278,41	286,11	-



Flat Cover

Complete the article code with L measure (for example XPF/ for L = 70 becomes XPF/70)

PP Drain Aqua

Design Cover stands out for the absolute elegance of its design and for the central drain. In polished or satin stainless steel AISI 316, it is available in different lengths, from 60 to 120 cm.



PP Drain Aqua - Design Cover satin stainless steel AISI 316 DIN 1.4404

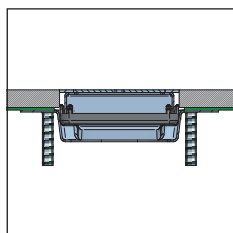

Design Cover



Design Cover

NEW DESIGN COVER - tiles thickness from 6 to 18 mm

ART.	finishing	L						
		60 cm	70 cm	80 cm	90 cm	100 cm	120 cm	
STAINLESS STEEL								
XPD/	polished stainless steel AISI 316 DIN 1.4404		22214	22215	22216	22217	22218	22219
	satin stainless steel AISI 316 DIN 1.4404		22220	22221	22222	22223	22224	22225
	euro/pc		86,46	94,27	103,84	118,69	126,94	149,60

With Invisible Cover, the shower tray and the linear shower drain become as one and blend perfectly with the bathroom covering. In natural aluminium and different lengths (from 60 to 120 cm), it disappears under the tile for a completely invisible aesthetic effect.

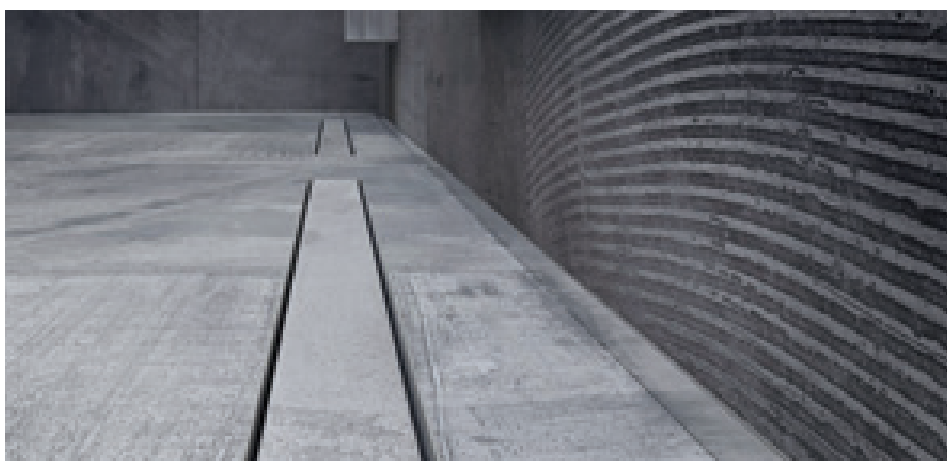

PP Drain Aqua - Invisible Cover

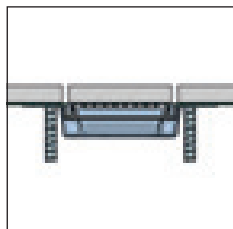

Invisible Cover



Invisible Cover

NEW INVISIBLE COVER

ART.	finishing	L						
		60 cm	70 cm	80 cm	90 cm	100 cm	120 cm	
ALUMINIUM								
XPI/	natural aluminium		22130	22131	22132	22133	22134	22135
	euro/pc		27,94	29,81	31,79	39,16	41,14	44,99

Complete the article code with L measure (for example XPD/ for L = 70 becomes XPD/70)

thin drain

thindrain

Thin Drain is a line of flush with the floor shower drains for a quick and easy installation, which allows to customize the shower with any kind of covering. Thanks to the syphon with low thickness and the height of the shower drain of just 55 mm, they are particularly suitable for refurbishments or in spaces where lightness and versatility are the main features.

ADVANTAGES

- Installation flush with the floor (it eliminates architectural barriers)
- Possibility of installation close to the wall
- Height of the shower drain of 55 mm (laying surface)
- Suitable for tiles with thickness up to 12 mm
- Possibility of laying tiles with thickness up to 12 mm with Tile Cover
- Shower drains with certification EN 1253-1 (minimum flow rate of 24 l/min)
- Supports for quick installation
- Integrated waterproof membrane to reduce the risk of seepages
- Possibility of inspection of the syphon for periodic cleaning
- Filter for cleaning/hair
- Quick installation
- Drain adapter from 4 to 50 mm included

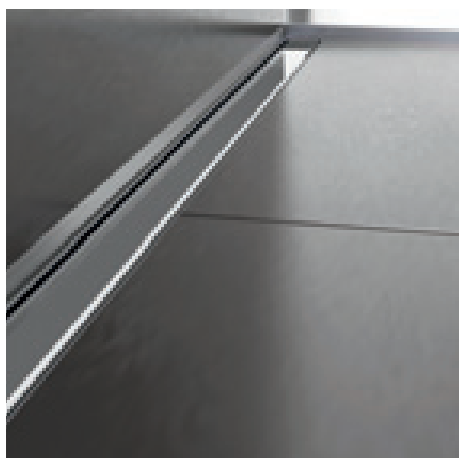

classic cover - polished stainless steel AISI 304 - DIN 1.4301

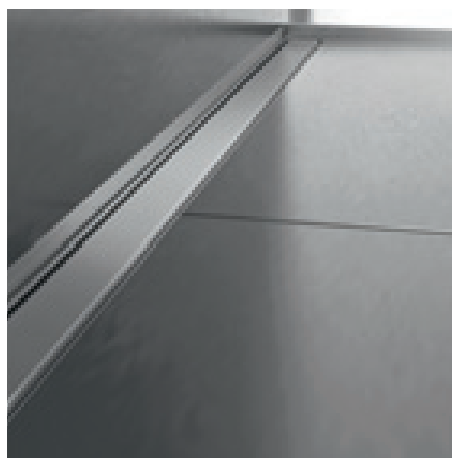

classic cover - satin stainless steel AISI 304 - DIN 1.4301

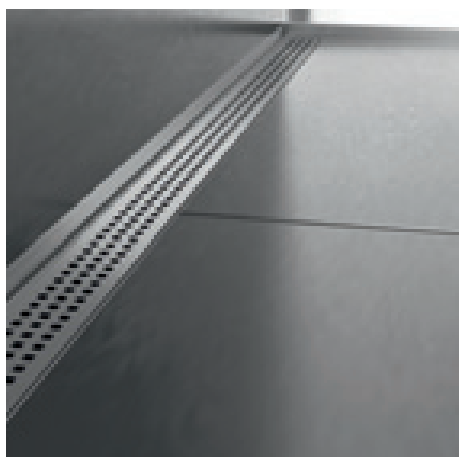

cube cover - satin stainless steel AISI 304 - DIN 1.4301

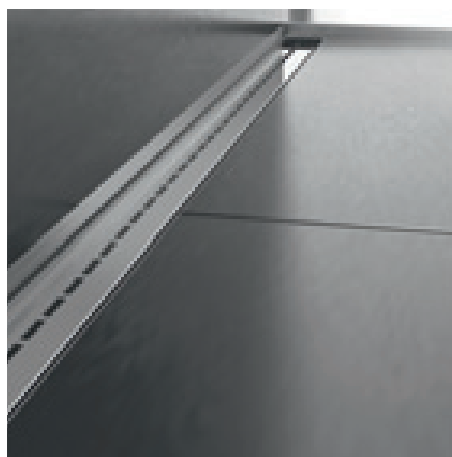

single line cover - polished stainless steel AISI 304 - DIN 1.4301



THIN DRAIN - BASE - pack 10 pcs

ART.	finishing		60 cm	70 cm	80 cm	90 cm	100 cm	120 cm
STAINLESS STEEL								
THIN/	stainless steel AISI 304 DIN 1.4301		19400	19401	19402	19403	19404	19405
	<i>euro/pc</i>		290,86	302,81	318,70	333,33	350,44	380,96



CLASSIC COVER - pack 10 pcs

ART.	finishing		60 cm	70 cm	80 cm	90 cm	100 cm	120 cm
STAINLESS STEEL								
XTC/	satin stainless steel AISI 304 DIN 1.4301		19410	19412	19414	19416	19418	19420
	polished stainless steel AISI 304 DIN 1.4301		19411	19413	19415	19417	19419	19421
	<i>euro/pc</i>		46,78	51,83	56,86	62,37	66,56	76,16



CUBE COVER - pack 10 pcs

ART.	finishing		60 cm	70 cm	80 cm	90 cm
STAINLESS STEEL						
XTCC/	satin stainless steel AISI 304 DIN 1.4301		19430	19431	19432	19433
	<i>euro/pc</i>		58,77	63,82	68,85	74,36



SINGLE LINE COVER - pack 10 pcs

ART.	finishing		60 cm	70 cm	80 cm	90 cm
XTL/	polished stainless steel AISI 304 DIN 1.4301		19440	19441	19442	19443
	<i>euro/pc</i>		58,77	63,82	68,85	74,36



TILE COVER - pack 10 pcs

ART.	finishing		60 cm	70 cm	80 cm	90 cm
XTT/	stainless steel AISI 304 DIN 1.4301		19450	19451	19452	19453
	<i>euro/pc</i>		58,77	63,82	68,85	74,36

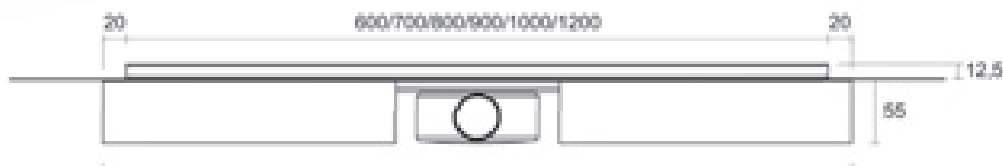
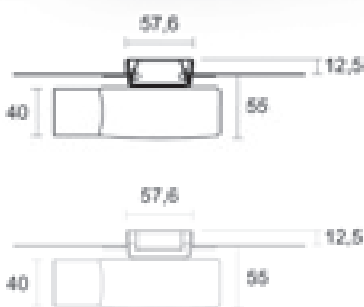
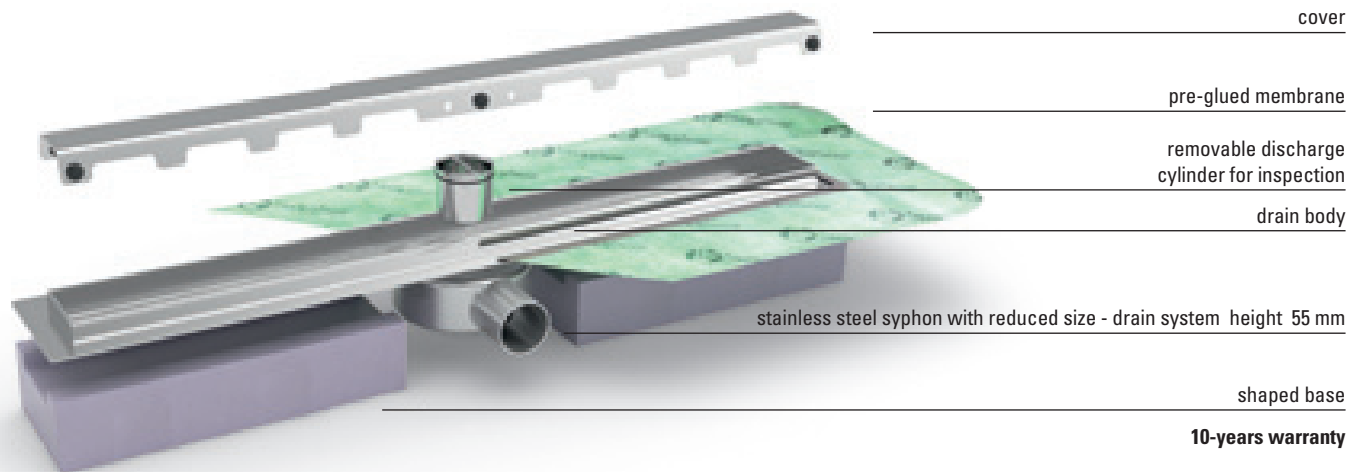

slim drain

slimdrain

Slim Drain is a line of flush with the floor shower drains for a quick and easy installation, which allows to customize the shower with any kind of covering and any tile thickness by choosing Slim Drain Invisible. Thanks to the syphon with low thickness and the height of the shower drain of just 65 mm, they are particularly suitable for refurbishments or in spaces where lightness and versatility are the main features.

ADVANTAGES

- Installation flush with the floor (it eliminates architectural barriers)
- Possibility of installation close to the wall
- Height of the shower drain of 65 mm (laying surface)
- Suitable for any tile thickness (Slim Invisible version)
- Adjustable frame (thickness 7-12,5 mm), Slim Invisible excluded.
- Shower drains with certification EN 1253-1 (minimum flow rate of 24 l/min)
- Integrated adjusting supports for an easy levelling
- Integrated waterproof membrane to reduce the risk of seepages
- Possibility of inspection of the syphon for periodic cleaning
- Filter for cleaning/hair
- Quick installation
- Drain adapter from 40 to 50 mm included

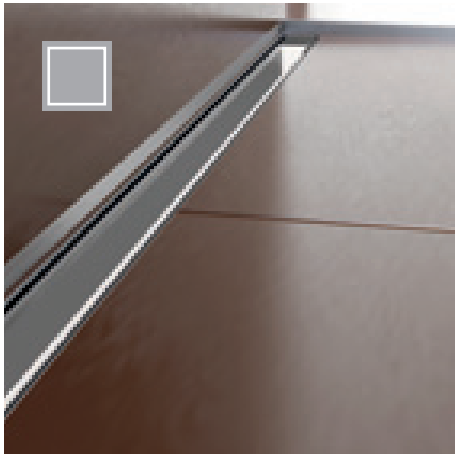

classic cover - polished stainless steel AISI 304 DIN 1.4301

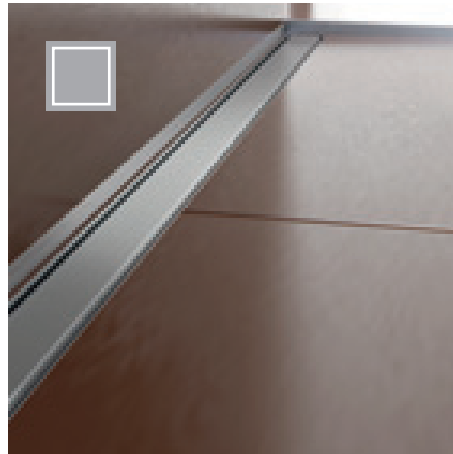

classic cover - satin stainless steel AISI 304 DIN 1.4301

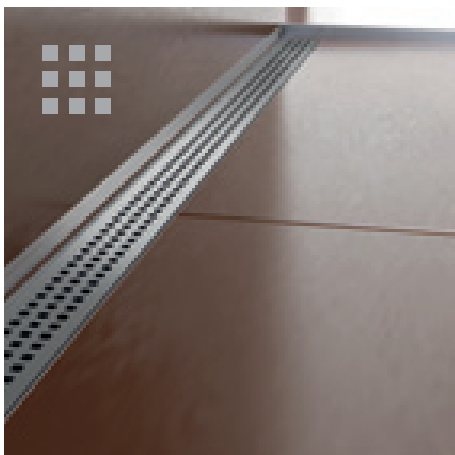

cube cover - satin stainless steel AISI 304 DIN 1.4301

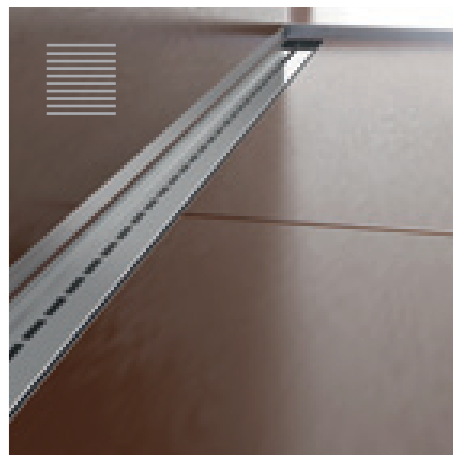

single line cover - polished stainless steel AISI 304 DIN 1.4301

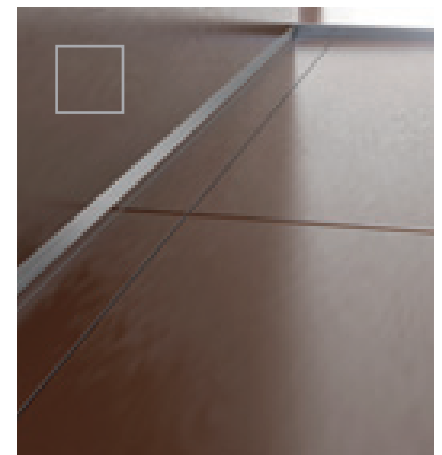

slim invisible - stainless steel AISI 304 DIN 1.4301



SLIM DRAIN - BASE - pack 10 pcs

ART.	finishing		60 cm	70 cm	80 cm	90 cm	100 cm	120 cm
STAINLESS STEEL								
SLIM/	stainless steel AISI 304 DIN 1.4301		19504	19506	19508	19510	19512	19514
	<i>euro/pc</i>		348,00	361,42	374,87	389,51	401,71	428,59

CLASSIC COVER - pack 10 pcs

ART.	finishing		60 cm	70 cm	80 cm	90 cm	100 cm	120 cm
STAINLESS STEEL								
XSC/	satin stainless steel AISI 304 DIN 1.4301		19524	19526	19528	19530	19532	19534
	polished stainless steel AISI 304 DIN 1.4301		19523	19525	19527	19529	19531	19533
	<i>euro/pc</i>		31,75	34,19	37,86	40,30	43,97	50,07

CUBE COVER - pack 10 pcs

ART.	finishing		60 cm	70 cm	80 cm	90 cm
STAINLESS STEEL						
XSCC/	satin stainless steel AISI 304 DIN 1.4301		19544	19546	19548	19550
	<i>euro/pc</i>		31,75	34,19	37,86	40,30

SINGLE LINE COVER - pack 10 pcs

ART.	finishing		60 cm	70 cm	80 cm	90 cm
XSL/	polished stainless steel AISI 304 DIN 1.4301		19563	19565	19567	19569
	<i>euro/pc</i>		31,75	34,19	37,86	40,30

SLIM INVISIBLE - BASE + COVER - pack 10 pcs

ART.	finishing		60 cm	70 cm	80 cm	90 cm
SLIM-I/	stainless steel AISI 304 DIN 1.4301		19505	19507	19509	19511
	<i>euro/pc</i>		354,10	367,53	382,18	394,39

Slim Invisible does not include the adjustable frame

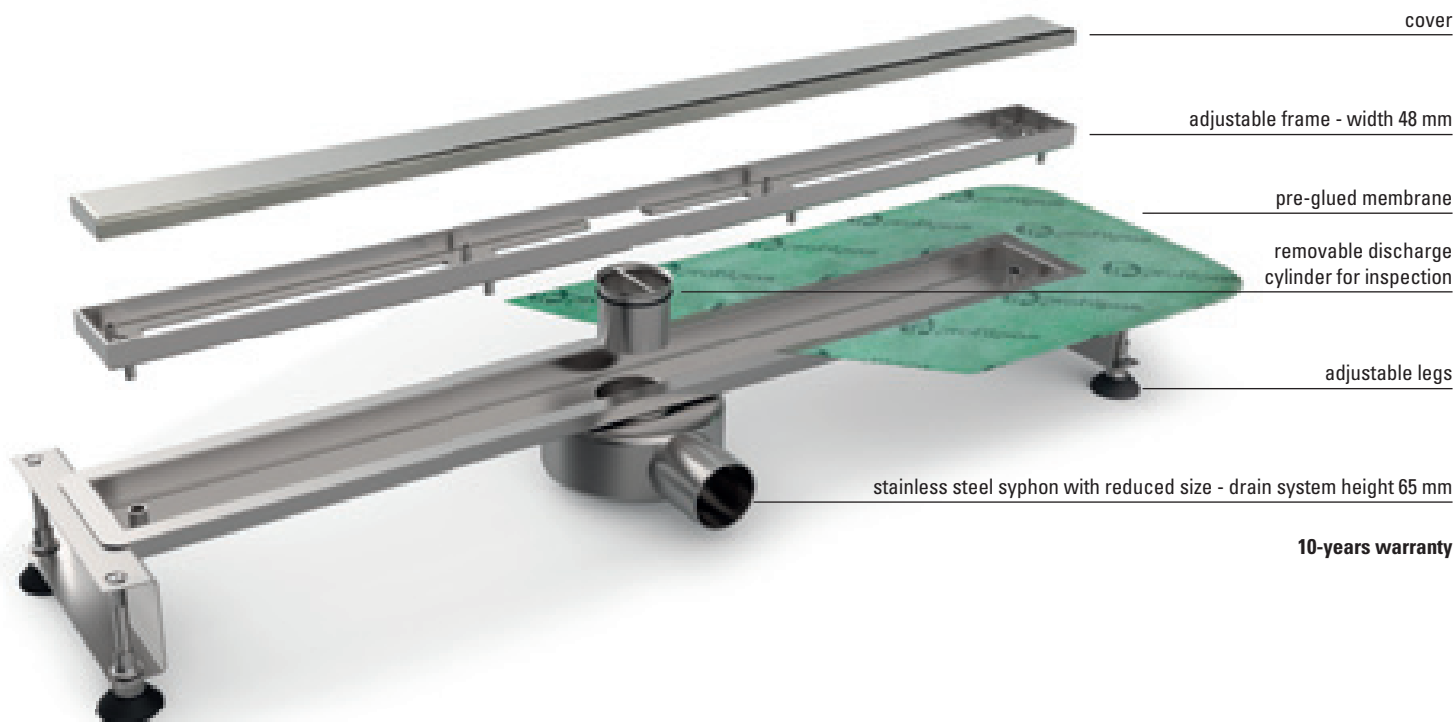
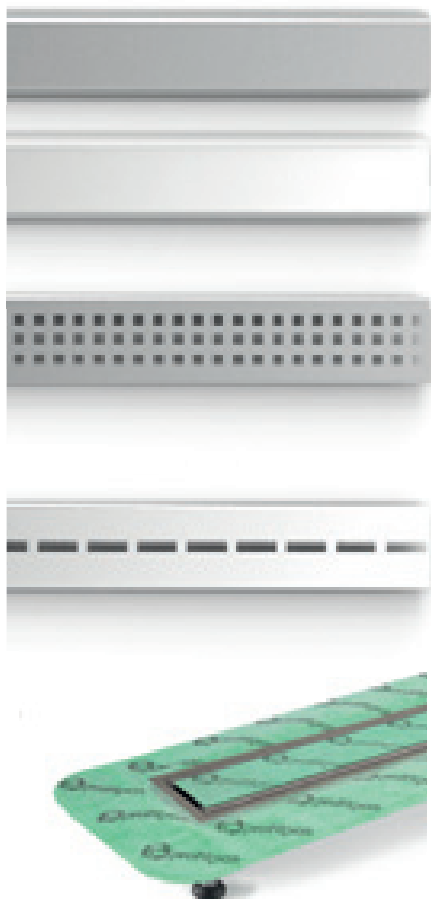

smart drain

smartdrain

Smart Drain is a line of flush with the floor shower drains for a quick and easy installation, which allows to customize the shower with any kind of covering and any tile thickness by choosing Smart Drain Invisible. With high aesthetic level, varied sizes available and the height of the shower drain of 75 mm, they are particularly suitable for large size of tiles in every space.

ADVANTAGES

- Installation flush with the floor (it eliminates architectural barriers)
- Possibility of installation close to the wall
- Height of the shower drain of 75 mm (laying surface)
- Suitable for tiles with every tiles thickness (Smart Invisible version)
- Adjustable frame (thickness 7-12,5 mm), excluded Smart Invisible.
- Orientable siphoned body.
- Shower drains with certification EN 1253-1 (minimum flow rate of 24 l/min)
- Integrated regular supports for a simple set - aside at the same level.
- Integrated waterproof membrane to reduce the risk of seepages
- Suitable Inox stain steel AISI 316 - DIN 14404 version
- 180° Ruotatable classic cover for tiles (maximum thickness 10 mm)
- Possibility of inspection of the syphon for periodic cleaning
- Filter for cleaning/hair
- Quick installation



classic cover - polished stainless steel AISI 304 DIN 1.4301



classic cover - satin stainless steel AISI 304 DIN 1.4301

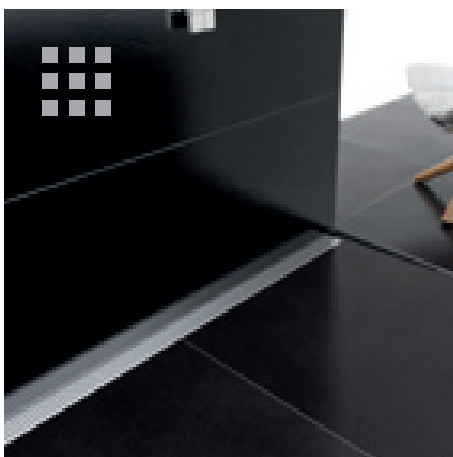

cube cover - satin stainless steel AISI 304 DIN 1.4301



double line cover - polished stainless steel AISI 304 DIN 1.4301

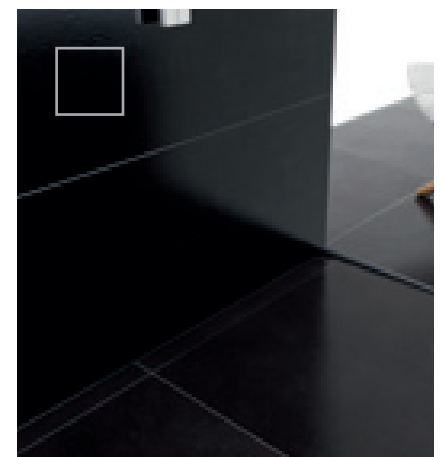

smart invisible - stainless steel AISI 304 DIN 1.4301



SMART DRAIN - BASE - pack 10 pcs

ART.	finishing		70 cm	80 cm	90 cm	100 cm	110 cm	120 cm
STAINLESS STEEL								
SMART/	stainless steel AISI 304 DIN 1.4301		19704	19706	19708	19710	19712	19714
	<i>euro/pc</i>		302,81	318,70	333,33	350,44	365,09	380,96
SMART3/	stainless steel AISI 316 DIN 1.4404		19715	19716	19717	19718	-	-
	<i>euro/pc</i>		332,13	349,23	367,53	385,85	-	-

CLASSIC COVER - pack 10 pcs

ART.	finishing		70 cm	80 cm	90 cm	100 cm	110 cm	120 cm
STAINLESS STEEL								
XLC/	satin stainless steel AISI 304 DIN 1.4301		19724	19726	19728	19730	19732	19734
	polished stainless steel AISI 304 DIN 1.4301		19723	19725	19727	19729	19731	19733
	<i>euro/pc</i>		75,73	79,37	83,03	86,70	90,35	94,03
XLC3/	satin stainless steel AISI 316 DIN 1.4404		19741	19742	19743	19744	-	-
	<i>euro/pc</i>		83,03	87,92	91,58	95,25	-	-

CUBE COVER - pack 10 pcs

ART.	finishing		70 cm	80 cm	90 cm	100 cm	110 cm	120 cm
STAINLESS STEEL								
XLCC/	satin stainless steel AISI 304 DIN 1.4301		19764	19766	19768	19770	19772	19774
	<i>euro/pc</i>		80,60	86,70	90,35	95,25	98,90	103,80

DOUBLE LINE COVER - pack 10 pcs

ART.	finishing		70 cm	80 cm	90 cm	100 cm	110 cm	120 cm
STAINLESS STEEL								
XLL/	polished stainless steel AISI 304 DIN 1.4301		19783	19785	19787	19789	19791	19793
	<i>euro/pc</i>		80,60	86,70	90,35	95,25	98,90	103,80

SMART INVISIBLE - BASE + COVER - pack 10 pcs

ART.	finishing		70 cm	80 cm	90 cm	100 cm	110 cm	120 cm
STAINLESS STEEL								
SMART-I/	stainless steel AISI 304 DIN 1.4301		19703	19705	19707	19709	19711	19713
	<i>euro/pc</i>		283,29	300,37	326,03	330,90	346,77	361,42

Smart Invisible does not include the adjustable frame

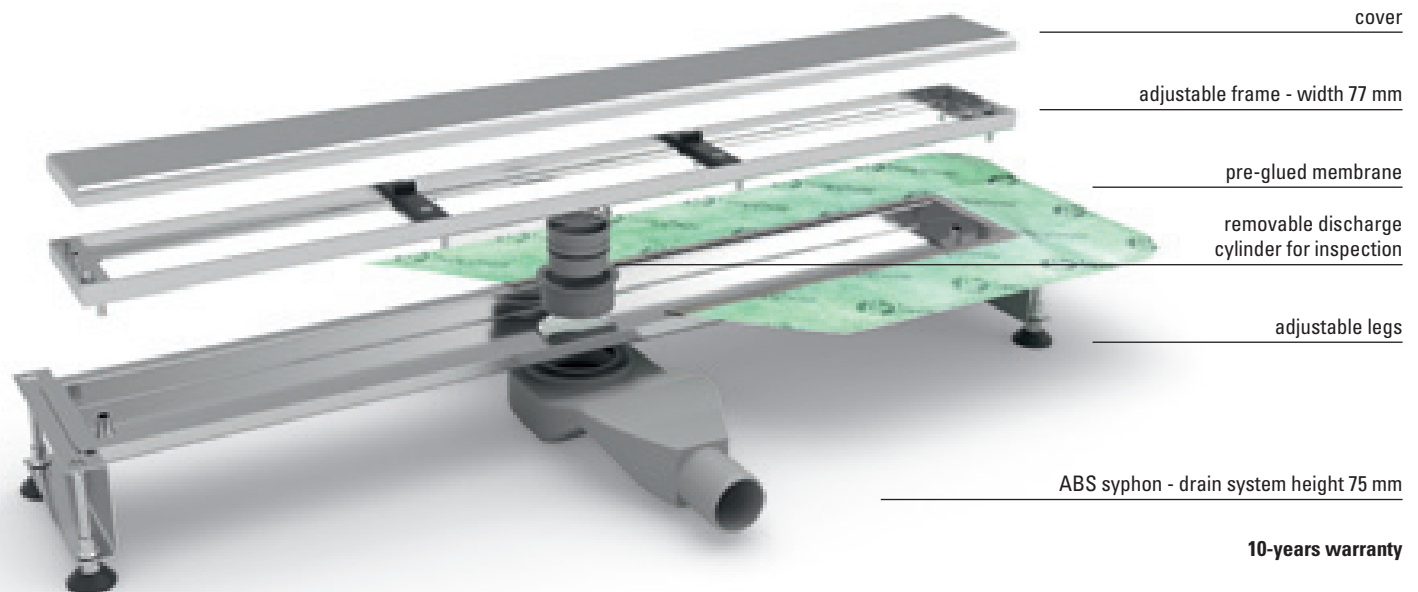
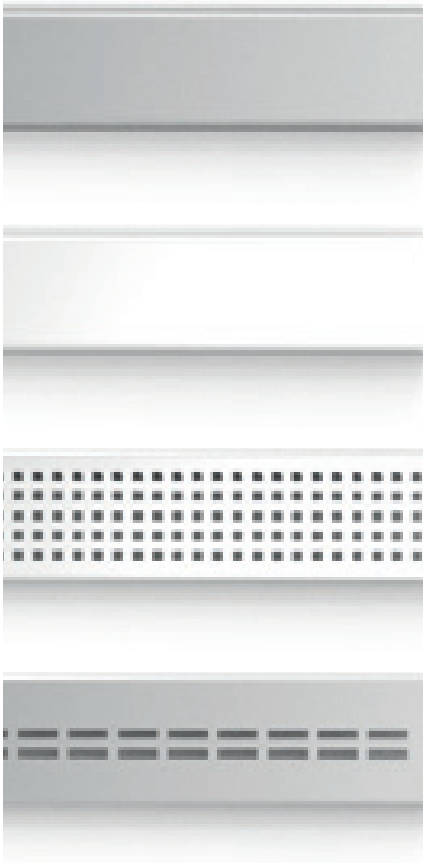

Q drain

q-drain

Q-Drain is a line of point drainages for flush with the floor showers which are quick and easy to install and allow to customize the shower with any kind of covering. Provided with insulating flange and with a height of 72/78 mm, they are the ideal solution for traditional showers flush with the floor.

ADVANTAGES

- Installation flush with the floor (it eliminates architectural barriers)
- Height of the point drainage of 72/78 mm (laying surface)
- Directable syphon
- Shower drains with certification EN 1253-1 (minimum flow rate of 24 l/min)
- Integrated waterproof membrane to reduce the risk of seepages
- Possibility of laying tiles with thickness up to 10 mm with Q Drain Tile
- Possibility of inspection of the syphon for periodic cleaning
- Filter for cleaning/hair
- Quick installation



Q Drain Cube



Q Drain Line



Q DRAIN CLASSIC - pack 10 pcs

ART.	finishing		10x10 cm
STAINLESS STEEL		floor thickness of 12,5 mm	
QDC/1010	satin stainless steel AISI 304 DIN 1.4301		19850
	polished stainless steel AISI 304 DIN 1.4301		19851
euro/pc			142,74

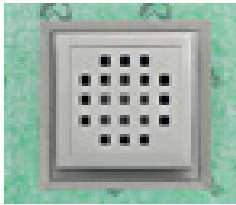

Q DRAIN CUBE - pack 10 pcs

ART.	finishing		10x10 cm
STAINLESS STEEL		floor thickness of 12,5 mm	
QDCC/1010	satin stainless steel AISI 304 DIN 1.4301		19852
	polished stainless steel AISI 304 DIN 1.4301		19853
euro/pc			142,74

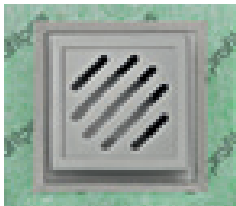

Q DRAIN LINE - pack 10 pcs

ART.	finishing		10x10 cm
STAINLESS STEEL		floor thickness of 12,5 mm	
QDL/1010	satin stainless steel AISI 304 DIN 1.4301		19854
	polished stainless steel AISI 304 DIN 1.4301		19855
euro/pc			142,74

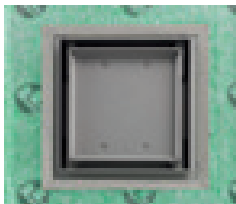

Q DRAIN TILE - pack 10 pcs

ART.	finishing		10x10 cm
STAINLESS STEEL		floor thickness of 10 mm	
QDI/1010	stainless steel AISI 304 DIN 1.4301		19856
euro/pc			142,74

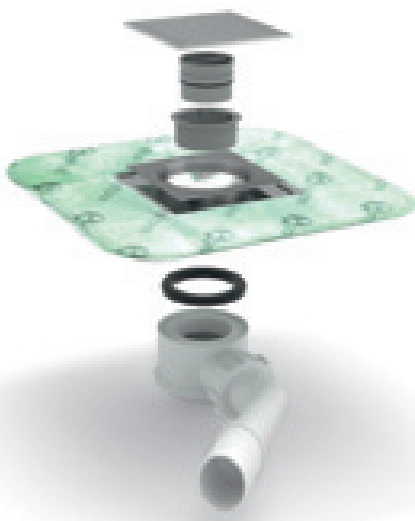

10-years warranty

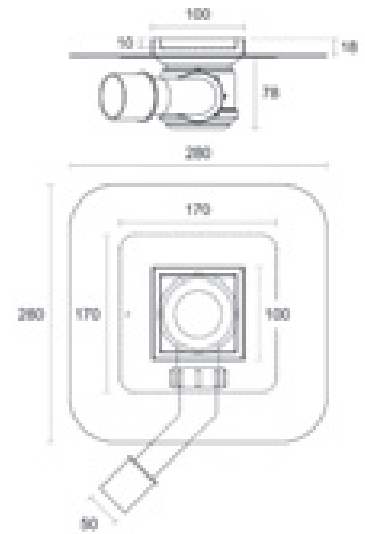
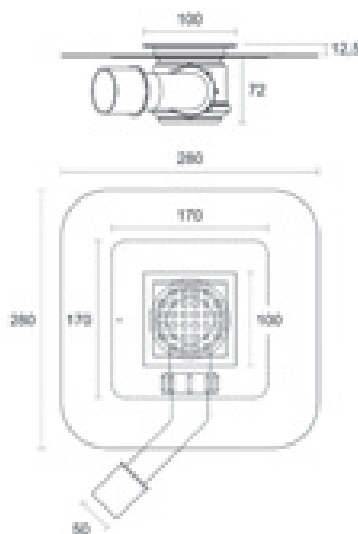

Glass Profile

The floor-level shower is a trendy and design element that represents a real opportunity for designing bathrooms of every dimension, highlighting their practicality and beauty. Removing the traditional shower tray, the floor-level shower can be made with the same covering of the bathroom, thus creating a uniform and elegant surface. Moreover, the absence of architectural barriers makes the access easier for children, elderly people or disabled.

Profilpas offers a series of integrated solutions for floor-level showers: a system of linear floor-level drains in stainless steel, with the possibility of also opting for the invisible version, thus creating a whole with the shower ceramic covering, which is completed by a wide range of stainless steel profiles for the insertion of glass walls and for finishing the sloping surface.



Glass Profile is a line of stainless steel profiles designed to cover the difference in height of the surface with 2% slope and create a coplanar surface with a modern and linear design. The range includes two finishes: satin stainless steel and matt black colour coated stainless steel. The versatility of these two colours become guarantee of elegance, assuring a minimalist and trendy effect.

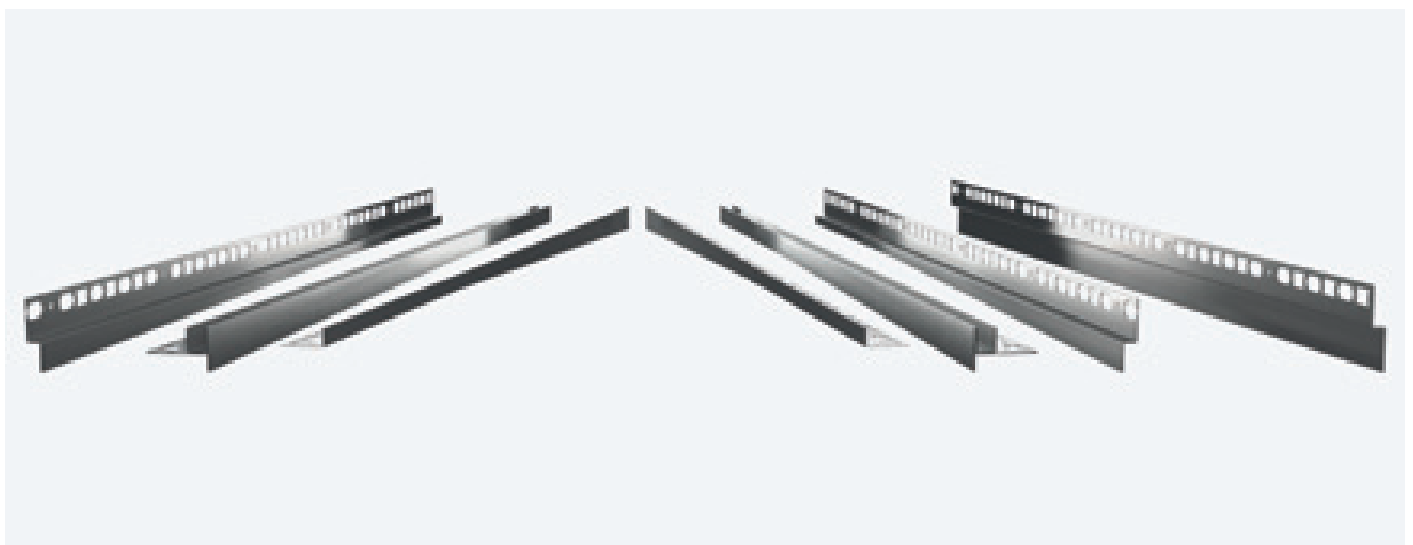

glass profile

Glass Profile GPS1/ is a stainless steel profile for the insertion of glass walls of floor-level showers. GPS1/ is provided with a 2% slope on the shower inner side for a perfect aesthetic solution of the sloped surface.

On completion of the profile, there is GPS/6, the end cap for hiding the section of the glass wall.

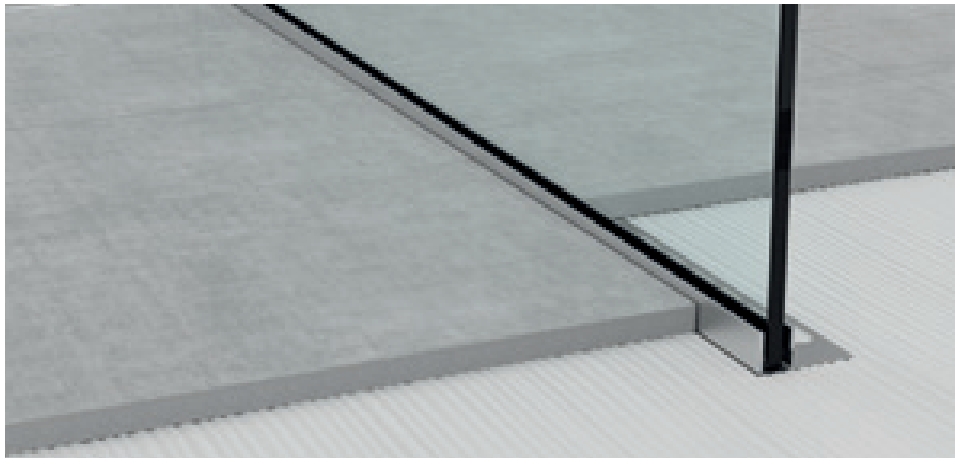

GPS1/DX/19 satin stainless steel AISI 304 DIN 1.4301

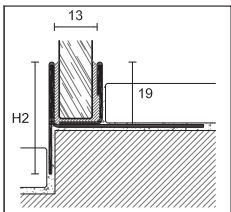

GPS1/DX/19

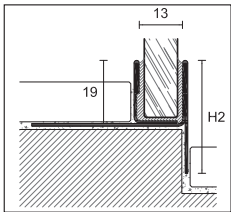

GPS1/SX/19

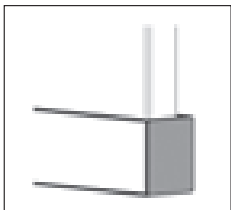

GPS/6

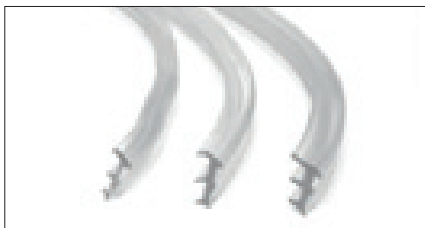

silicone glazing beads

GLASS PROFILE

pack 5 pcs

ART.	GPS1/ /19							
	DX		SX		DX		SX	
length cm	98		120		148		200	
H2 mm	34		37		42		60	

STAINLESS STEEL

satin stainless steel AISI 304 DIN 1.4301		31505	31507	31515	31517	31525	31527	31535	31537
euro/pc		74,00	74,00	78,96	78,96	88,83	88,83	146,80	146,80

NEW

MATT BLACK COLOUR-COATED STAINLESS STEEL

matt black RAL 9005 colour-coated stainless steel AISI 304 DIN 1.4301		31506	31508	31516	31518	31526	31528	-	-
euro/pc		82,31	82,31	89,15	89,15	101,39	101,39	-	-

individually packed

GLASS PROFILE - END CAP FOR GPS1//19

pack 5 pcs

ART.	GPS/6	
satin stainless steel AISI 304 DIN 1.4301		31564
euro/pc		6,93

NEW

MATT BLACK COLOUR-COATED STAINLESS STEEL

matt black RAL 9005 colour-coated stainless steel AISI 304 DIN 1.4301		31566
euro/pc		8,69

no partial packaging

TRANSPARENT SILICONE GLAZING BEADS

pack 5 mt

ART.	measures	
GG/2	thickness 2 mm	31590
	euro/pack	19,39
GG/3	thickness 3 mm	31592
	euro/pack	20,54
GG/4	thickness 4 mm	31594
	euro/pack	22,45

no partial packaging

Complete the article code with DX and SX (DX = RH and SX = LH) - for example GPS1//19 RH becomes GPS1/DX/19. For a single piece, see sales conditions on page 288

Glass Profile GPS2/ and GPS14/12 are two stainless steel profiles for inserting glass walls on the wall covering. GPS2/ is simple to install, is suitable for tiles of any thickness and does not require drilling. GPS/6 is the end cap to complete the profile, to hide the visible section of the glass wall. GPS14/12 can be fixed directly onto the already-laid wall covering.



GPS2/19 satin stainless steel AISI 304 DIN 1.4301

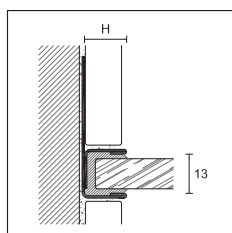

GPS2/



GLASS PROFILE

length = 210 cm - pack 5 pcs

ART.	finishing	NEW 10	NEW 12,5	19
------	-----------	--------	----------	----

STAINLESS STEEL

GPS2/	satin stainless steel AISI 304 DIN 1.4301		31541	31542	31543
	<i>euro/pc</i>		70,18	71,68	76,18

NEW MATT BLACK COLOUR-COATED STAINLESS STEEL

GPS2/	matt black RAL 9005 colour-coated stainless steel AISI 304 DIN 1.4301		31546	31547	31545
	<i>euro/pc</i>		88,02	89,52	94,02

individually packed

GLASS PROFILE

length = 250 cm - pack 5 pcs

ART.	finishing	NEW 10	NEW 12,5	19
------	-----------	--------	----------	----

STAINLESS STEEL

GPS2/	satin stainless steel AISI 304 DIN 1.4301		31548	31549	31544
	<i>euro/pc</i>		87,70	89,62	95,22

individually packed

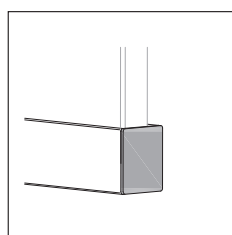

GPS/6

GLASS PROFILE - END CAP FOR GPS2/19

pack 5 pcs

ART.	GPS/6
------	-------

STAINLESS STEEL

GPS2/	satin stainless steel AISI 304 DIN 1.4301		31564
	<i>euro/pc</i>		6,93

NEW MATT BLACK COLOUR-COATED STAINLESS STEEL

GPS2/	matt black RAL 9005 colour-coated stainless steel AISI 304 DIN 1.4301		31566
	<i>euro/pc</i>		8,69

no partial packaging

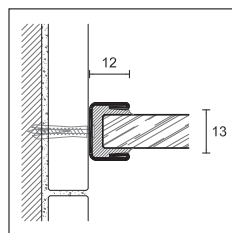

GPS14/12



GLASS PROFILE

pack 5 pcs

ART.	GPS14/12
------	----------

STAINLESS STEEL

length cm	210	250	
satin stainless steel AISI 304 DIN 1.4301		32000	32001
<i>euro/pc</i>	20,90	24,89	

individually packed

Complete the article code with H measure (for example GPS2/ for H=10 becomes GPS2/10).

For a single piece, see sales conditions on page 288

glass profile

Glass Profile GPS3/ is a stainless steel profile provided with a 2% slope on the shower inner side for a perfect aesthetic solution of the sides of the sloped surface.

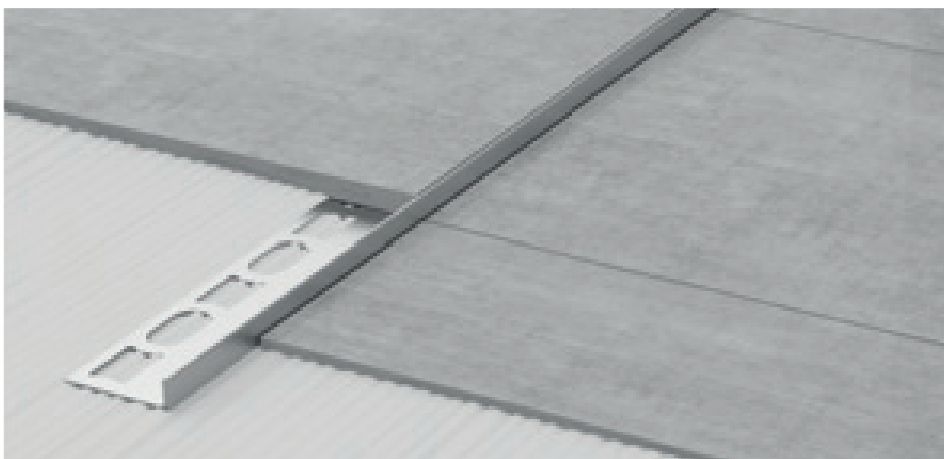

GPS3/SX/10 satin stainless steel AISI 304 DIN 1.4301

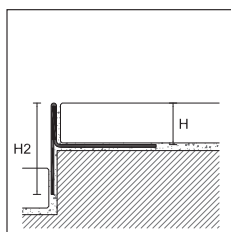

GPS3/DX/

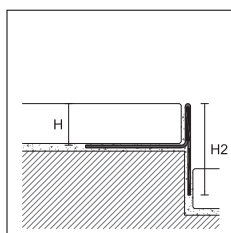

GPS3/SX/



GLASS PROFILE

length = 98 cm - pack 5 pcs

ART.	finishing		H	H2	DX	SX
STAINLESS STEEL						
GPS3/ /10	satin stainless steel AISI 304 DIN 1.4301		10	25	31615	31617
	<i>euro/pc</i>				38,79	38,79
NEW GPS3/ /11	satin stainless steel AISI 304 DIN 1.4301		11	26	31619	31620
	<i>euro/pc</i>				39,11	39,11
GPS3/ /12	satin stainless steel AISI 304 DIN 1.4301		12,5	27,5	31625	31627
	<i>euro/pc</i>				39,47	39,47
NEW MATT BLACK COLOUR-COATED STAINLESS STEEL						
GPS3/ /10	matt black RAL 9005 colour-coated stainless steel AISI 304 DIN 1.4301		10	25	31616	31618
	<i>euro/pc</i>				47,12	47,12
GPS3/ /11	matt black RAL 9005 colour-coated stainless steel AISI 304 DIN 1.4301		11	26	31629	31630
	<i>euro/pc</i>				47,44	47,44
GPS3/ /12	matt black RAL 9005 colour-coated stainless steel AISI 304 DIN 1.4301		12,5	27,5	31626	31628
	<i>euro/pc</i>				47,81	47,81

individually packed

GLASS PROFILE

length = 120 cm - pack 5 pcs

ART.	finishing		H	H2	DX	SX
STAINLESS STEEL						
GPS3/ /10	satin stainless steel AISI 304 DIN 1.4301		10	28	31645	31647
	<i>euro/pc</i>				41,33	41,33
NEW GPS3/ /11	satin stainless steel AISI 304 DIN 1.4301		11	29	31649	31650
	<i>euro/pc</i>				41,87	41,87
GPS3/ /12	satin stainless steel AISI 304 DIN 1.4301		12,5	30,5	31655	31657
	<i>euro/pc</i>				42,48	42,48
NEW MATT BLACK COLOUR-COATED STAINLESS STEEL						
GPS3/ /10	matt black RAL 9005 colour-coated stainless steel AISI 304 DIN 1.4301		10	28	31646	31648
	<i>euro/pc</i>				51,52	51,52
GPS3/ /11	matt black RAL 9005 colour-coated stainless steel AISI 304 DIN 1.4301		11	29	31652	31654
	<i>euro/pc</i>				52,15	52,15
GPS3/ /12	matt black RAL 9005 colour-coated stainless steel AISI 304 DIN 1.4301		12,5	30,5	31656	31658
	<i>euro/pc</i>				52,68	52,68

individually packed







GPS3/ is also available in 8 mm height on request, with a minimum order of 30 pcs.

Complete the article code with DX and SX (DX = RH and SX = LH) - for example GPS3/ /10 RH becomes GPS3/DX/ /10

For a single piece, see sales conditions on page 288

GLASS PROFILE



length = 148 cm - pack 5 pcs

ART.	finishing		H	H2	DX	SX
STAINLESS STEEL						
GPS3/ /10	satin stainless steel AISI 304 DIN 1.4301		10	33	31675	31677
	<i>euro/pc</i>				45,72	45,72
NEW GPS3/ /11	satin stainless steel AISI 304 DIN 1.4301		11	34	31679	31680
	<i>euro/pc</i>				46,32	46,32
GPS3/ /12	satin stainless steel AISI 304 DIN 1.4301		12,5	35,5	31685	31687
	<i>euro/pc</i>				46,87	46,87
NEW MATT BLACK COLOUR-COATED STAINLESS STEEL						
GPS3/ /10	matt black RAL 9005 colour-coated stainless steel AISI 304 DIN 1.4301		10	33	31676	31678
	<i>euro/pc</i>				58,19	58,19
GPS3/ /11	matt black RAL 9005 colour-coated stainless steel AISI 304 DIN 1.4301		11	34	31682	31684
	<i>euro/pc</i>				58,83	58,83
GPS3/ /12	matt black RAL 9005 colour-coated stainless steel AISI 304 DIN 1.4301		12,5	35,5	31686	31688
	<i>euro/pc</i>				59,47	59,47

individually packed

GLASS PROFILE

length = 200 cm - pack 5 pcs

ART.	finishing		H	H2	DX	SX
STAINLESS STEEL						
GPS3/ /10	satin stainless steel AISI 304 DIN 1.4301		10	51	31694	31695
	<i>euro/pc</i>				68,92	68,92
GPS3/ /12	satin stainless steel AISI 304 DIN 1.4301		12,5	53,5	31698	31699
	<i>euro/pc</i>				70,89	70,89

individually packed



glass profile

Glass Profile GPS4/ is a stainless steel profile provided with a 2% slope on the shower inner side. It connects the sloped floor and the covering perfectly, thus avoiding the oblique cut of the tiles.



GPS4/DX/10 matt black RAL 9005 colour-coated stainless steel AISI 304 DIN 1.4301

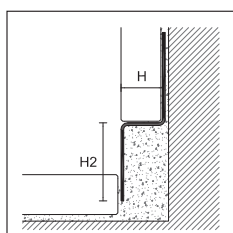

GPS4/DX/



GLASS PROFILE

length = 98 cm - pack 5 pcs

ART.	finishing	H	H2	DX	SX	
STAINLESS STEEL						
GPS4/ /10	satin stainless steel AISI 304 DIN 1.4301		10	23	31715	31717
	<i>euro/pc</i>				38,21	38,21
GPS4/ /11	satin stainless steel AISI 304 DIN 1.4301		11	23	31716	31718
	<i>euro/pc</i>				38,48	38,48
GPS4/ /12	satin stainless steel AISI 304 DIN 1.4301		12,5	23	31725	31727
	<i>euro/pc</i>				38,63	38,63

NEW

NEW

MATT BLACK COLOUR-COATED STAINLESS STEEL

GPS4/ /10	matt black RAL 9005 colour-coated stainless steel AISI 304 DIN 1.4301		10	23	31719	31720
	<i>euro/pc</i>				46,53	46,53
GPS4/ /11	matt black RAL 9005 colour-coated stainless steel AISI 304 DIN 1.4301		11	23	31722	31724
	<i>euro/pc</i>				46,80	46,80
GPS4/ /12	matt black RAL 9005 colour-coated stainless steel AISI 304 DIN 1.4301		12,5	23	31726	31728
	<i>euro/pc</i>				46,95	46,95

individually packed

GLASS PROFILE

length = 120 cm - pack 5 pcs

ART.	finishing	H	H2	DX	SX	
STAINLESS STEEL						
GPS4/ /10	satin stainless steel AISI 304 DIN 1.4301		10	26	31745	31747
	<i>euro/pc</i>				40,77	40,77
GPS4/ /11	satin stainless steel AISI 304 DIN 1.4301		11	26	31746	31748
	<i>euro/pc</i>				41,02	41,02
GPS4/ /12	satin stainless steel AISI 304 DIN 1.4301		12,5	26	31755	31757
	<i>euro/pc</i>				41,19	41,19

NEW

GPS4/ is also available in 8 mm height on request, with a minimum order of 30 pcs.

Completare codice articolo con DX e SX (for example GPS4/ /8 DX becomes GPS4/DX/8)

For a single piece, see sales conditions on page 288

NEW MATT BLACK COLOUR-COATED STAINLESS STEEL

GPS4/ /10	matt black RAL 9005 colour-coated stainless steel AISI 304 DIN 1.4301	■	10	26	31749	31750
	<i>euro/pc</i>				50,94	50,94
GPS4/ /11	matt black RAL 9005 colour-coated stainless steel AISI 304 DIN 1.4301	■	11	26	31752	31754
	<i>euro/pc</i>				51,20	51,20
GPS4/ /12	matt black RAL 9005 colour-coated stainless steel AISI 304 DIN 1.4301	■	12,5	26	31756	31758
	<i>euro/pc</i>				51,37	51,37

individually packed

GLASS PROFILE

length = 148 cm - pack 5 pcs

ART.	finishing		H	H2	DX	SX
STAINLESS STEEL						
GPS4/ /10	satin stainless steel AISI 304 DIN 1.4301	▨	10	31	31775	31777
	<i>euro/pc</i>				44,90	44,90
NEW GPS4/ /11	satin stainless steel AISI 304 DIN 1.4301	▨	11	31	31776	31778
	<i>euro/pc</i>				45,16	45,16
GPS4/ /12	satin stainless steel AISI 304 DIN 1.4301	▨	12,5	31	31785	31787
	<i>euro/pc</i>				45,48	45,48

NEW MATT BLACK COLOUR-COATED STAINLESS STEEL

GPS4/ /10	matt black RAL 9005 colour-coated stainless steel AISI 304 DIN 1.4301	■	10	31	31779	31780
	<i>euro/pc</i>				57,46	57,46
GPS4/ /11	matt black RAL 9005 colour-coated stainless steel AISI 304 DIN 1.4301	■	11	31	31782	31784
	<i>euro/pc</i>				57,72	57,72
GPS4/ /12	matt black RAL 9005 colour-coated stainless steel AISI 304 DIN 1.4301	■	12,5	31	31786	31800
	<i>euro/pc</i>				58,05	58,05

individually packed

GLASS PROFILE

length = 200 cm - pack 5 pcs

ART.	finishing		H	H2	DX	SX
STAINLESS STEEL						
GPS4/ /10	satin stainless steel AISI 304 DIN 1.4301	▨	10	49	31794	31795
	<i>euro/pc</i>				75,30	75,30
GPS4/ /12	satin stainless steel AISI 304 DIN 1.4301	▨	12,5	49	31798	31799
	<i>euro/pc</i>				76,12	76,12

individually packed



GPS4/SX/10 satin stainless steel AISI 304 DIN 1.4301

glass profile

Glass Profile GPS5/ is a stainless steel profile to be positioned on the wall covering, above the shower drain with sloped surface, in order to avoid the cut of the tiles.

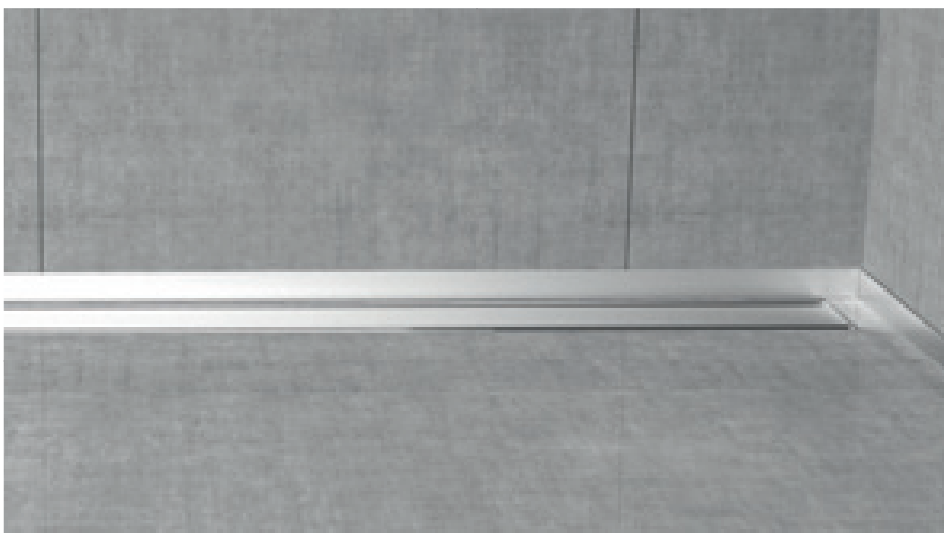

GPS5/ satin stainless steel AISI 304 DIN 1.4301

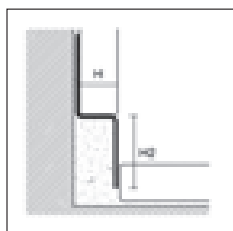







GPS5/



GLASS PROFILE

length = 125 cm - pack 5 pcs

ART.	finishing		H		H2	
STAINLESS STEEL						
				23	33	45
GPS5/10/	satin stainless steel AISI 304 DIN 1.4301		10	31551	31553	31559
	euro/pc			30,82	31,38	32,81
NEW GPS5/11/	satin stainless steel AISI 304 DIN 1.4301		11	31563	31572	-
	euro/pc			30,95	31,54	-
GPS5/12/	satin stainless steel AISI 304 DIN 1.4301		12,5	31555	31557	31561
	euro/pc			31,10	31,65	33,08
NEW MATT BLACK COLOUR-COATED STAINLESS STEEL						
GPS5/10/	matt black RAL 9005 colour-coated stainless steel AISI 304 DIN 1.4301		10	31567	31568	-
	euro/pc			41,42	41,98	-
GPS5/11/	matt black RAL 9005 colour-coated stainless steel AISI 304 DIN 1.4301		11	31570	31571	-
	euro/pc			41,55	42,14	-
GPS5/12/	matt black RAL 9005 colour-coated stainless steel AISI 304 DIN 1.4301		12,5	31573	31574	-
	euro/pc			41,70	42,25	-

individually packed

GPS5/ is also available in 8 mm height on request, with a minimum order of 30 pcs.

Complete the article code with H2 measure (for example GPS5/10/ for H2 = 23 becomes GPS5/10/23).

For a single piece, see sales conditions on page 288



GPS5/ matt black RAL 9005 colour-coated stainless steel AISI 304 DIN 1.4301

GU/ and TGU/ are anodised aluminium profiles suitable for the insertion of glass walls on the floor and on the wall of floor-level showers.

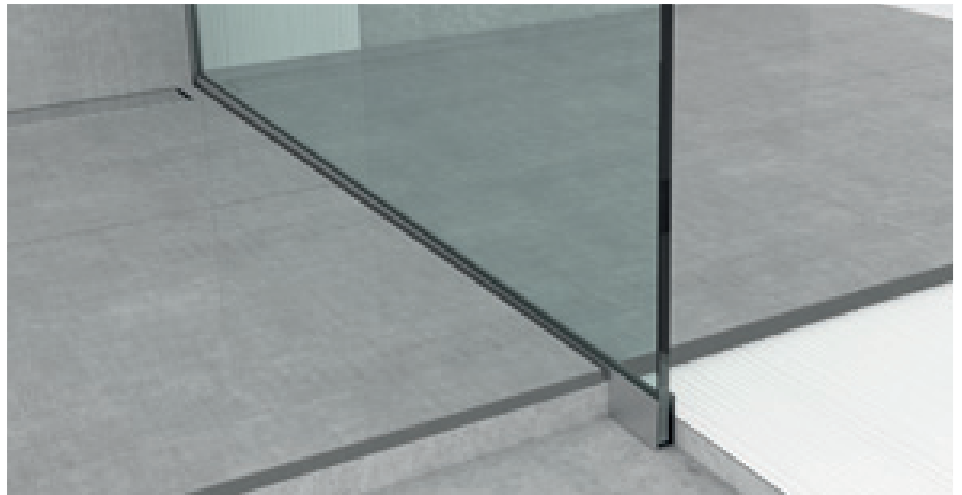

GU/40/12 + TGU/12 silver anodised aluminium

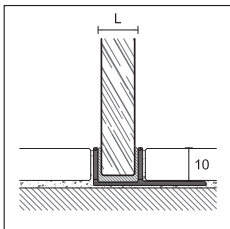

TGU/



GLASS PROFILE

length = 270 cm - pack 10 pcs

		L	
ART.	finishing	12	14
ALUMINIUM			
TGU/	silver anodised	67760	67762
	euro/m	6,48	6,48

individually packed

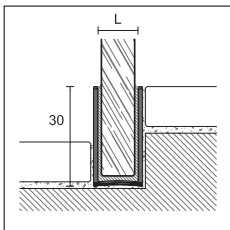

GU/30/

GLASS PROFILE

length = 270 cm - pack 10 pcs

		L	
ART.	finishing	12	14
ALUMINIUM			
GU/30/	silver anodised	67770	67772
	euro/m	7,00	7,00

individually packed

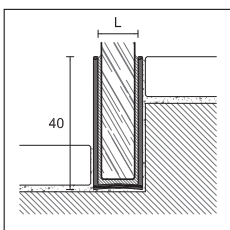

GU/40/

GU/40/	silver anodised	67780	67782
	euro/m	8,27	8,27

individually packed

Complete the article code with L measure
(for example GU/30/ per L = 12 becomes
GU/30/12)

For a single piece, see sales conditions on page 288

wpstop

WPstop is a waterproof membrane in polyethylene with a textile in polypropylene in both sides in order to facilitate the grip of the adhesive, thus ensuring a high adhesion to the support. It is particularly suitable for the waterproofing of floors and tiled walls of bathrooms.

PAIG/ are special pre-formed pieces for waterproofing the internal corners of floor-level showers using Glass Profile GPS1 and GPS3.

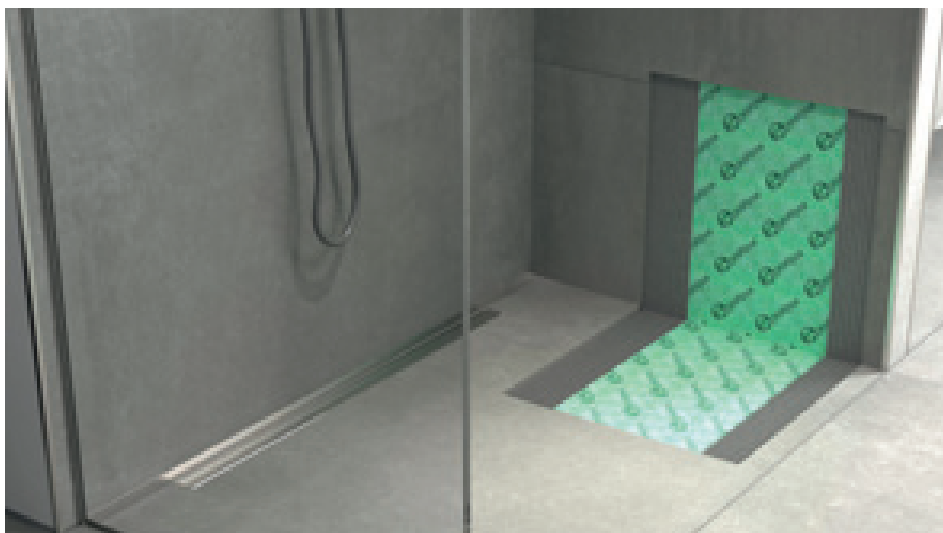

sistema Wpstop



rolls



stripes

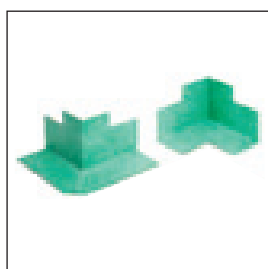

corners

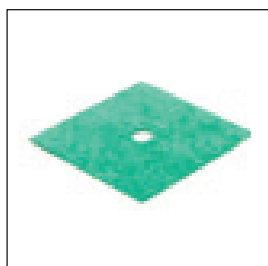

colar

WPSTOP

ART. measures

PR30	roll 1 m height 30 mt length - pack 1 roll	19900
	euro/m	10,37
PR5	roll 1 m height 5 mt length - pack 6 rolls	19902
	euro/m	12,16
PB30	stripe 14 cm height 30 mt length - pack 1 roll	19910
	euro/m	3,18
PB5	stripe 14 cm height 5 mt length - pack 6 rolls	19912
	euro/m	4,12
PAE	outside corner - pack 10 pcs	19920
	euro/pc	7,65
PAI	inside corner - pack 10 pcs	19922
	euro/pc	7,65
PF12	colar cm 12x12 - pack 10 pcs	19930
	euro/pc	5,95

no partial packaging

INSTRUCTIONS

Store in a cool and dry place, avoiding direct exposure to sunlight and heat sources.

Please refer to the technical data sheet before the installation. For special installations, please contact our technical department.

NEW WPSTOP - CORNERS FOR GLASS PROFILE GPS1 AND GPS3

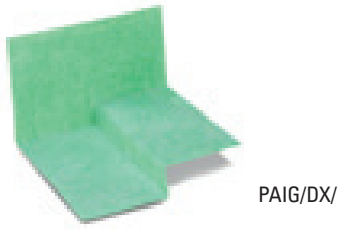

PAIG/DX/

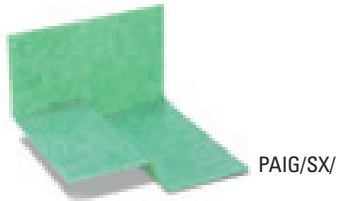

PAIG/SX/

ART.	measures	RX	LH
PAIG//15	inside corner - pack 10 pcs	19931	19932
	euro/pc (euro/pack.)	14,31 (143,10)	14,31 (143,10)
PAIG//20	inside corner - pack 10 pcs	19933	19934
	euro/pc (euro/pack.)	14,31 (143,10)	14,31 (143,10)
PAIG//28	inside corner - pack 10 pcs	19935	19936
	euro/pc (euro/pack.)	14,31 (143,10)	14,31 (143,10)
PAIG//38	inside corner - pack 10 pcs	19937	19938
	euro/pc (euro/pack.)	14,31 (143,10)	14,31 (143,10)

no partial packaging

INSTRUCTIONS

Store in a cool and dry place, avoiding direct exposure to sunlight and heat sources.

Please refer to the technical data sheet before the installation. For special installations, please contact our technical department.

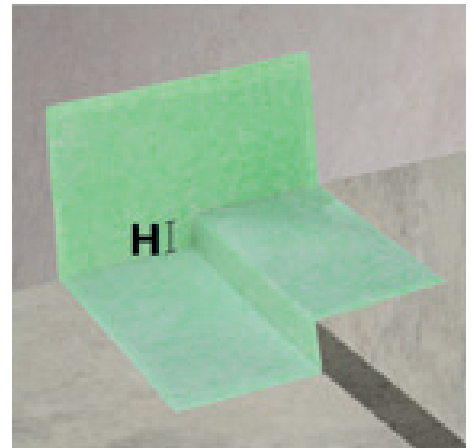
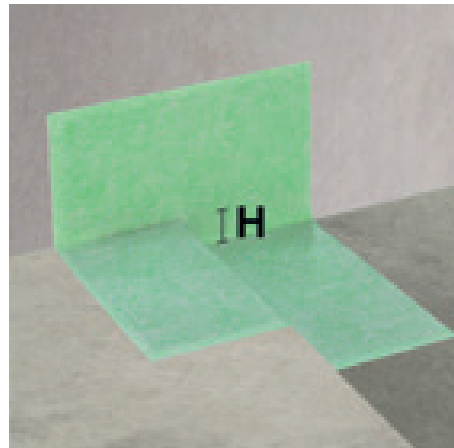

Complete the article code with DX and SX (DX = RH and SX = LH) - for example PAIG//15 RH becomes PAIG/DX/15.

For a single piece, see sales conditions on page 288

glass profile

Sanibord BP/22 and BP/25 are technical profiles in coextruded PVC to be installed between the covering and the bath tub or shower tray during the laying. These profiles allow to avoid the use of silicone and, besides the aesthetic advantages, guarantee a high hygienic level over time.



BP/22



BP/25

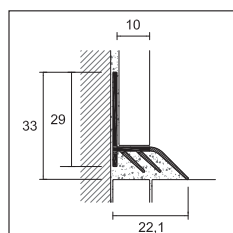

BP/22



SANIBORD

length = 270 cm - pack 20 pcs

ART. finishing

CO-EXTRUDED PVC

BP/22	anti-mould white	<input type="checkbox"/>	95520
	<i>euro/m</i>		6,73

no partial packaging

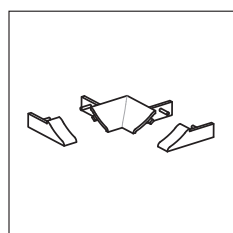

BPT/22

INSIDE CORNER AND RIGHT/LEFT END CAPS FOR BP/22

pack 6 blister

ART. finishing

POLYPROPYLENE

BPT/22	white	<input type="checkbox"/>	95530
	<i>euro/blister</i>		4,53

no partial packaging

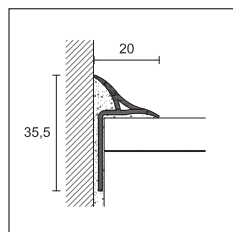

BP/25

SANIBORD

length = 270 cm - pack 20 pcs

ART. finishing

CO-EXTRUDED PVC

BP/25	anti-mould white	<input type="checkbox"/>	95540
	<i>euro/m</i>		6,73

no partial packaging

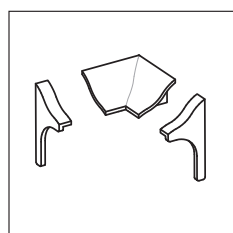

BPT/25

INSIDE CORNER AND RIGHT/LEFT END CAPS FOR BP/25

pack 6 blister

ART. finishing

POLYPROPYLENE

BPT/25	white	<input type="checkbox"/>	95545
	<i>euro/blister</i>		4,53

no partial packaging

KIT: 1 PC OF 180 CM + 2 PCS OF 90 CM + 2 INSIDE CORNERS AND RIGHT/LEFT END CAPS

pack 10 pcs

ART. finishing

CO-EXTRUDED PVC

BPK/25	anti-mould white	<input type="checkbox"/>	95494
	<i>euro/kit</i>		32,43

individually packed - no partial packaging

Sanibord BH/20 and BP/20 are technical profiles in colour-coated aluminium and coextruded PVC to be installed between the covering and the bath tub or the shower tray. These profiles allow to avoid the use of silicone and, besides the aesthetic advantages, guarantee a high hygienic level over time.

BH/20 in colour-coated aluminium is provided with the certified antibacterial technology (according to the internationally recognized laboratory test JIS Z 2801:2000) which allows to reduce the presence of the most dangerous bacteria up to 99%.



BP/20 anti-mould white co-extruded PVC

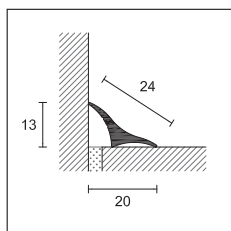

BH/20

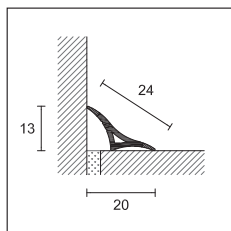

BP/20

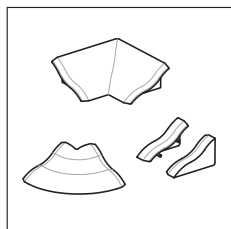

BPT/20

SANIBORD

length = 270 cm - pack 20 pcs

ART. finishing

ANTIBACTERIAL COLOUR-COATED ALUMINIUM

BH/20	colour-coated white antibacterial RAL 9003	<input type="checkbox"/>	95459
	euro/m		8,20
BH/20/A adhesive	colour-coated white antibacterial RAL 9003	<input type="checkbox"/>	95460
	euro/m		9,27

SANIBORD

length = 270 cm - pack 20 pcs

ART. finishing

CO-EXTRUDED PVC

BP/20	anti-mould white	<input type="checkbox"/>	95490
	euro/m		4,45
BP/20/A adhesive	anti-mould white	<input type="checkbox"/>	95470
	euro/m		5,86

no partial packaging

INSIDE CORNER, OUTSIDE CORNER, RIGHT/LEFT END CAPS FOR BH/20 AND BP/20

pack 6 blister

ART. finishing

POLYPROPYLENE

BPT/20	white	<input type="checkbox"/>	95480
	euro/blister		6,29

no partial packaging

KIT: 1 PC OF 180 CM + 2 PCS OF 90 CM + 2 INSIDE CORNERS AND RIGHT/LEFT END CAPS

pack 10 pcs

ART. finishing

CO-EXTRUDED PVC

BPK/20	anti-mould white	<input type="checkbox"/>	95544
	euro/kit		27,26

individually packed excepted BP20 - no partial packaging

MS POLYMER-BASED ADHESIVE FOR SKIRTING BOARDS

quantity 290 ml - pack 24 pcs

ART.

PP/96		<input type="checkbox"/>	78301
	euro/pc		18,81

