



profiles for wooden, laminated and LVT floors

A full range of profiles for wooden, laminate and LVT floors. A series of systems and professional solutions proposed in different colours of anodised aluminium and in the exclusive finishes Alcrom® Plus, with the possibility of further customization thanks to PDS technology.

profiles for wooden and laminate floors

unisystem plus



Unisystem Plus is a system for the floating installation of wooden and laminate floors from 6,5 to 22,6 mm thickness. Composed of connection profiles for same and different level floors, perimetral profiles and stair nosing profiles, Unisystem Plus is easy to lay and simple to remove. The system is composed of a top profile, an aluminium base and a fixing clip: after inserting the fixing clip in the top profile, just push the top profile to fix it to the aluminium base.

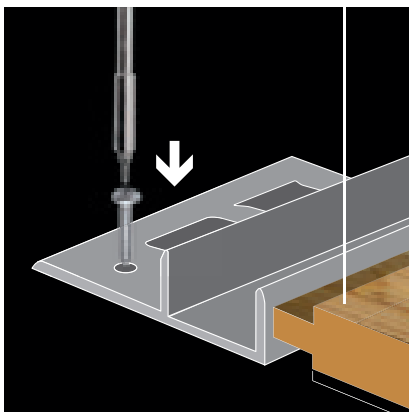

fix the aluminium base to the subfloor with screws or glue

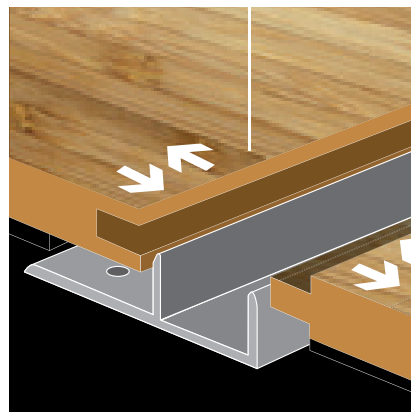

bring the floor planks closer

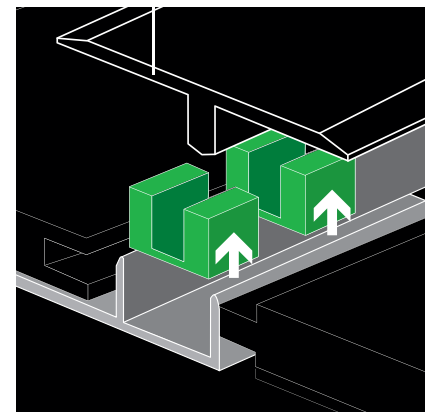

insert the clips in the top profile

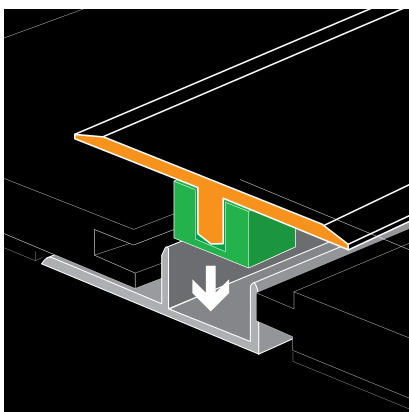

put the top profile in the base

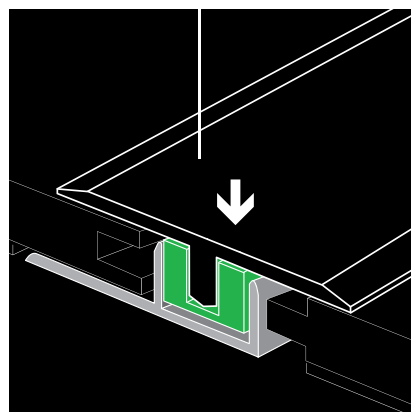

push the top profile in the base

Unisystem Plus line

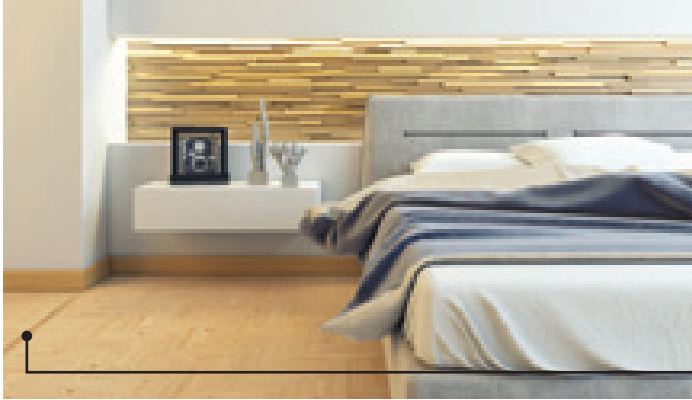

Connection profiles for floors of same level

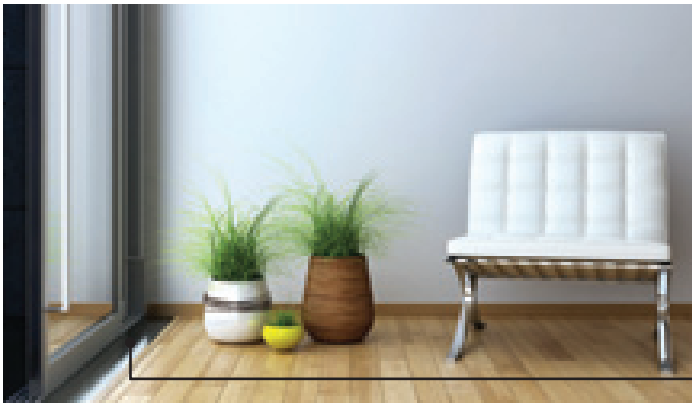

Connection profiles for floors of different level



Perimetral profiles

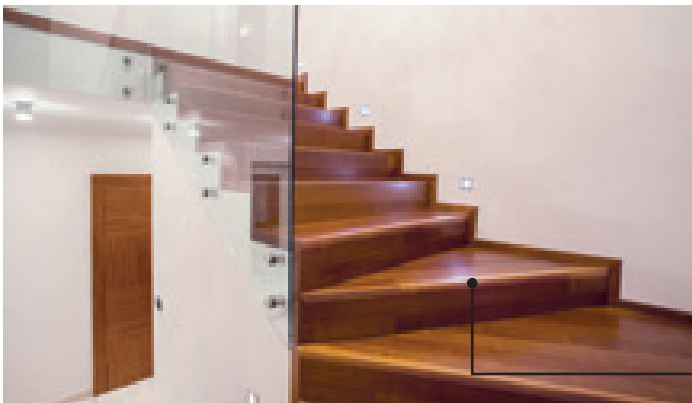

Stair nosing profiles



unisystem - unisystem plus

Unisystem Plus is a system for the floating installation of wooden and laminate floors from 6,5 to 22,6 mm thickness, composed of junction profiles for same level floors (Z/ series), connection profiles for different level floors (C/ series) and perimetral profiles (S/ series). The system is composed of a natural aluminium base and a top profile to be fixed on the base through a specific clip. The top profile is available in different finishes of anodised aluminium or covered with wood-effect Alcrom® Plus film for matching the floor perfectly.



Unisystem Plus S/9/SF, Z/1/SF and C/7/SF

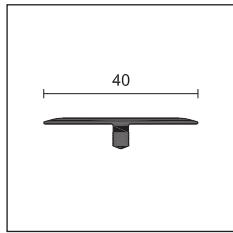

Z/1/SF

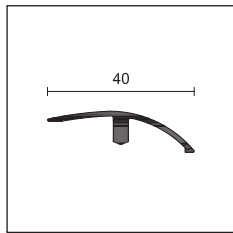

C/7/SF

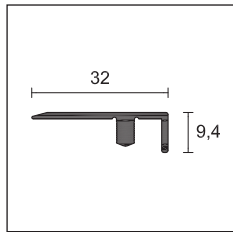

S/9/SF

UNISYSTEM/ UNISYSTEM PLUS

length = 270 cm - pack 10 pcs

ART.	finishing	Z/1/SF	C/7/SF	S/9/SF
floor thickness from / to mm		6,5/22,6	6,5/10	6,5/22,6

ALUMINIUM covered with ALCROM® PLUS film

02	66301	66001	65701
05	66306	66006	65706
08	66304	66004	65704
10	66307	66007	65707
11	66308	66008	65708
12	66309	66009	65709
13	66310	66010	65710
14	66311	66011	65711
18	66316	66016	65716
19	66318	66018	65718
20	66317	66017	65717
26	66321	66021	65721
31	66328	66028	65728
32	66329	66029	65729
34	66331	66031	65731
35	66332	66032	65732
36	66333	66033	65733
37	66334	66034	65734
38	66335	66035	65735
39	66336	66036	65736
40	66337	66037	65737
41	66338	66038	65738
42	66339	66039	65739
43	66340	66040	65740
44	66341	66041	65741
47	66344	66044	65744
65	66365	66065	65765
71	66368	66068	65768
72	66369	66069	65769
73	66370	66070	65770
74	66371	66071	65771
76	66374	66074	65774
77	66372	66072	65772
78	66376	66076	65776
79	66373	66073	65773
80	66377	66077	65777
81	66378	66078	65778
89	66386	66086	65784

euro/m

11,43

individually packed

UNISYSTEM/ UNISYSTEM PLUS

length = 270 cm - pack 10 pcs

ART.	finishing	Z/1/SF	C/7/SF	S/9/SF
floor thickness from / to mm		6,5/22,6	6,5/10	6,5/22,6

ALUMINIUM covered with ALCROM® PLUS film

91	66388	66088	65786	
92	66389	66089	65789	
93	66390	66090	65790	
94	66391	66091	65791	
95	66392	66092	65792	
351	66393	66093	-	
363	66394	66094	-	
372	66395	66095	-	
490	66397	66097	-	
560	66398	66098	-	
580	66399	66099	65793	
590	66400	66100	-	
665	66401	66101	65794	
670	66402	66102	65795	
951	66408	66108	65797	
975	66409	66109	65798	
1024	66410	66110	65799	
1033	66411	66111	65800	
1042	66412	66112	65801	
1090	66414	66114	65803	
1202	66416	66116	65805	
1203	66417	66117	65806	
1204	66418	66118	65807	
1205	66419	66119	65808	
1206	66420	66120	65809	
1207	66421	66121	65810	
1208	66422	66122	65811	
1209	66423	66123	65812	
1210	66424	66124	65813	
1211	66425	66125	65814	
1212	66426	66126	65815	
1213	66427	66127	65816	
1214	66428	66128	65817	
1215	66429	66129	65818	
1216	66430	66130	65819	
1217	66431	66131	65820	
100	66432	66132	-	
NEW	black 97	66433	66133	65821

euro/m

11,43

individually packed

For a single piece, see sales conditions on page 288

Profiles of 270 cm length: please order the base separately.

Customized PDS decors on request, see page 195



UNISYSTEM/ UNISYSTEM PLUS

length = 270 cm - pack 20 pcs

ART.	finishing	Z/1/SF	C/7/SF	S/9/SF
floor thickness from / to mm		6,5/22,6	6,5/10	6,5/22,6

ANODISED ALUMINIUM

silver		67217	67007	65680
euro/m		6,86	6,86	6,86
titanium		67238	67000	65691
gold		67227	67017	65685
gold sand		67234	67024	65688
bronze		67237	67027	65690
euro/m		7,49	7,49	7,49

Other models for thicker floors available on page 176 individually packed

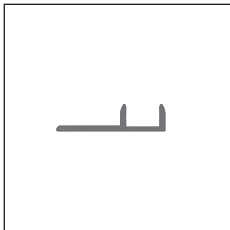

TPU/

UNISYSTEM PLUS - BASES

floor thickness from / to mm	6,5/10	9,6/12,5	12,6/15,5	15/19	19,6/22,6
------------------------------	--------	----------	-----------	-------	-----------

length = 270 cm
pack 20 pcs (15 clips TU/6 included)

ART.	finishing	6	10	13	15	22
------	-----------	---	----	----	----	----

ALUMINIUM

TPU/	natural aluminium		67437	67447	67457	67460	67467
	euro/m		4,71	5,26	5,74	6,41	8,37

individually packed (art. TPU/22 pack 10 pcs)

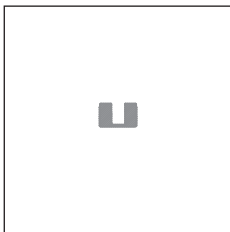

TU/6

SPARE CLIPS

pack of 150 pcs

	H
	6

TU/6	68812/150
------	-----------

euro/pack	22,42
------------------	--------------

no partial packaging

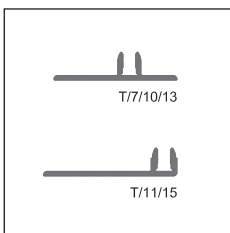

T/

UNISYSTEM - BASES

floor thickness from / to mm	6,5/10	10,12	6,5/10	13/15	11/15
------------------------------	--------	-------	--------	-------	-------

length = 270 cm - pack 20 pcs

ART.	finishing	7	10	11	13	15
------	-----------	---	----	----	----	----

ALUMINIUM

T/	natural aluminium		67287	67297	67317	67307	67327
	euro/m		4,71	5,26	4,67	5,74	5,30



Z/1/SF aluminium covered with Alcrom® Plus film



C/7/SF aluminium covered with Alcrom® Plus film



S/9/SF aluminium covered with Alcrom® Plus film

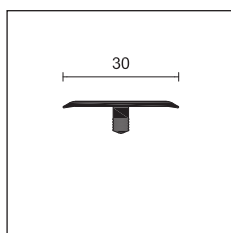

Z3/30/SF

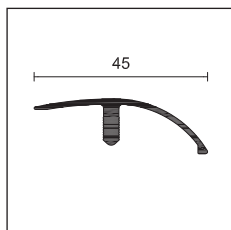

C/10/SF

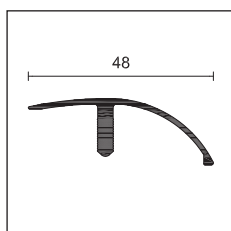

C/13/SF

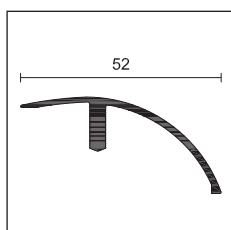

C/22/SF

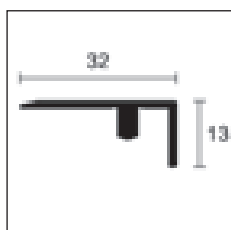

S/15/SF

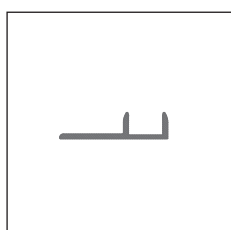

TPU/

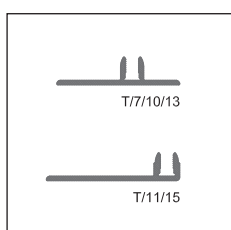

T/

UNISYSTEM - UNISYSTEM PLUS

length = 270 cm	pack 20 pcs	pack 20 pcs	pack 10 pcs	pack 10 pcs	pack 10 pcs	
ART.	finishing	Z3/30/SF	C/10/SF	C/13/SF	C/22/SF	S/15/SF
floor thickness from / to mm		6,5/22,6	9,6/12,5	12,6/15,5	15/22,6	9,6/22,6

ANODISED ALUMINIUM

silver		63700	67077	67147	66907	65480
euro/m		6,42	7,76	9,04	14,83	7,18
gold		63702	67087	67157	-	-
gold sand		63704	-	-	-	65488
euro/m		7,05	8,39	9,67	-	7,81

individually packed

UNISYSTEM PLUS - BASES

floor thickness from / to mm	6,5/10	9,6/12,5	12,6/15,5	15/19	19,6/22,6
------------------------------	--------	----------	-----------	-------	-----------

length = 270 cm	pack 20 pcs (15 clips TU/6 included)	H				
ART.	finishing	6	10	13	15	22

ALUMINIUM

TPU/	natural aluminium		67437	67447	67457	67460	67467
euro/m			4,71	5,26	5,74	6,41	8,37

individually packed (art. TPU/22 pack 10 pcs)

SPARE CLIPS

pack da 150 pcs	H
	6

TU/6	68812/150
-------------	-----------

euro/pack	22,42
------------------	--------------

no partial packaging

UNISYSTEM - BASES

floor thickness from / to mm	6,5/10	10/12	6,5/10	13/15	11/15
------------------------------	--------	-------	--------	-------	-------

length = 270 cm - pack 20 pcs	H					
ART.	finishing	7	10	11	13	15

ALUMINIUM

T/	natural aluminium		67287	67297	67317	67307	67327
euro/m			4,71	5,26	4,67	5,74	5,30



Customized PDS decors on request, see page 195

For a single piece, see sales conditions on page 288

Z3/30/SF silver anodised aluminium

unisystem - unisystem plus

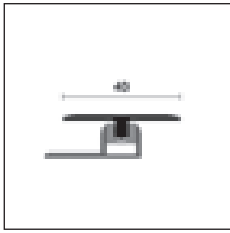

TPZ/

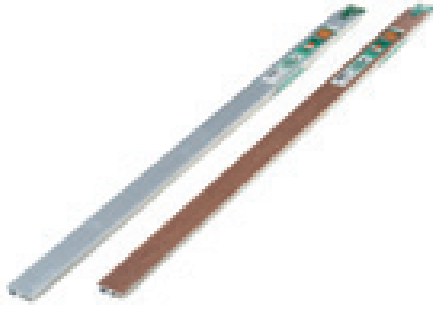

TPZ/47/CV silver anodised aluminium and aluminium covered with Alcrom® Plus film

UNISYSTEM PLUS

length = 90 cm - pack 10 pcs / blister - for floor thicknesses from 6,5 to 10 mm

ART. finishing

ALUMINIUM covered with ALCROM® PLUS film

	05	43005		77	43011		1208	43027
	10	43020		78	43066		1209	43029
	14	43006		80	43068		1210	43030
	19	43007		89	43012		1211	43031
	20	43028		91	43013		1212	43033
TPZ/47/CV	26	43008		580	43014		1213	43035
	31	43009		1202	43016		1214	43037
	38	43034		1203	43017		1215	43039
	39	43010		1204	43018		1216	43041
	40	43036		1205	43019		1217	43043
	42	43038		1206	43025			
	65	43056		1207	43026			
	euro/pc				15,96			

individually packed

UNISYSTEM PLUS

length = 90 cm - pack 10 pcs / blister

ART. finishing

ANODISED ALUMINIUM

ART.	finishing	TPZ/47/CV	TPZ/410/CV	TPZ/413/CV
floor thickness from / to mm				
		6,5 / 10	9,6 / 12,5	12,6 / 15,5
silver		43000	43072	43144
gold		43004	43076	43148
euro/pc		11,85	12,36	12,81

individually packed - gold anodised extra euro/pc + 0,57

UNISYSTEM PLUS

length = 90 cm - pack 10 pcs / blister - for floor thicknesses from 6,5 to 10 mm

ART. finishing

ALUMINIUM covered with ALCROM® PLUS film

	05	43219		77	43225		1208	43239
	10	43234		78	43280		1209	43240
	14	43220		80	43282		1210	43241
	19	43221		89	43226		1211	43243
	20	43242		91	43227		1212	43244
TPC/47/CV	26	43222		580	43228		1213	43245
	31	43223		1202	43231		1214	43247
	38	43248		1203	43232		1215	43249
	39	43224		1204	43233		1216	43251
	40	43250		1205	43235		1217	43253
	42	43252		1206	43236			
	65	43270		1207	43237			
	euro/pc				15,96			

individually packed

UNISYSTEM PLUS

length = 90 cm - pack 10 pcs / blister

ART. finishing

ANODISED ALUMINIUM

ART.	finishing	TPC/47/CV	TPC/410/CV	TPC/413/CV
floor thickness from / to mm				
		6,5 / 10	9,6 / 12,5	12,6 / 15,5
silver		43214	43286	43358
gold		43218	43290	43362
euro/pc		11,85	12,59	13,83

individually packed - gold anodised extra euro/pc + 0,57

UNISYSTEM PLUS

length = 90 cm - pack 10 pcs / blister

ART. finishing

ANODISED ALUMINIUM

ART.	finishing	TPS/47/CV	TPS/410/CV	TPS/413/CV
floor thickness from / to mm				
		6,5 / 10	9,6 / 12,5	12,6 / 15,5
silver		43430	43502	43574
euro/pc		11,85	12,88	13,32

individually packed

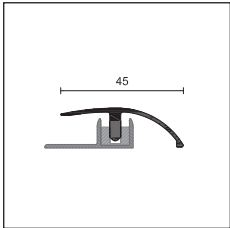

TPC/

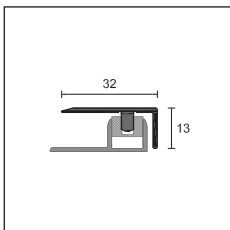

TPS/

The blister pack contains base, clips and profile.

unisystem plus

G/2/SF is a stair nosing profile of Unisystem Plus line. Composed of a base and a top profile, it is suitable for the installation of floating wooden and laminate with thicknesses from 6,5 to 12,5 mm.

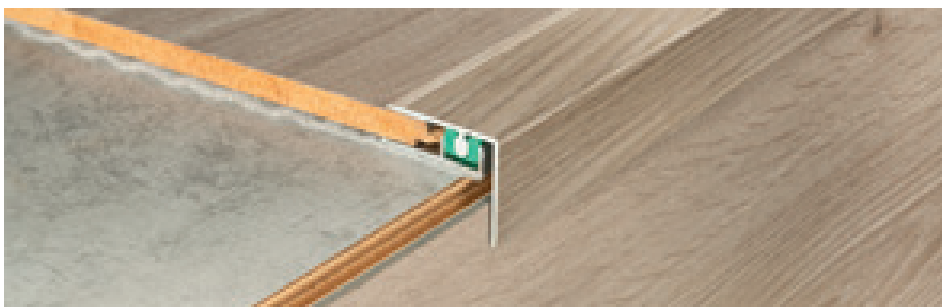

G/2/SF aluminium covered with Alcrom® Plus film

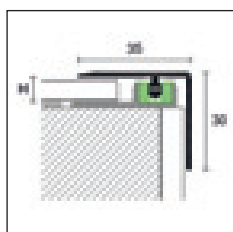

G/2/SF + TPU/



UNISYSTEM PLUS

length = 270 cm - pack 10 pcs - for floor thicknesses from 6,5 to 12,5 mm

ART. finishing

ALUMINIUM covered with ALCROM® PLUS film

	05	43645		41	43656		1207	43668
	08	43646		77	43657		1208	43669
	12	43647		89	43658		1209	43670
	13	43648		91	43659		1210	43671
	14	43649		93	43660		1211	43672
G/2/SF	19	43650		580	43661		1212	43673
	26	43651		1202	43663		1213	43674
	32	43652		1203	43664		1214	43675
	36	43653		1204	43665		1215	43676
	39	43654		1205	43666		1216	43677
	40	43655		1206	43667		1217	43678
	euro/m				12,11			

individually packed

UNISYSTEM PLUS

length = 270 cm - pack 10 pcs - for floor thicknesses from 6,5 to 12,5 mm

ART. finishing

ANODISED ALUMINIUM

	silver		43690
G/2/SF	euro/m		7,22
	titanium		43691
	euro/m		7,85

individually packed

UNISYSTEM PLUS - BASES

floor thickness from / to mm		6,5/10	9,6/12,5
length = 270 cm - pack 20 pcs (15 clips TU/6 included)		H	
ART.	finishing	6	10
ALUMINIUM			
TPU/	natural aluminium	67437	67447
	euro/m	4,71	5,26

individually packed

SPARE CLIPS

pack 150 pcs	H
	6
TU/6	68812/150
euro/pack	22,42

no partial packaging

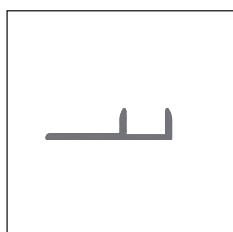

TPU/

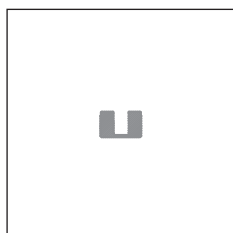

TU/6

For a single piece, see sales conditions on page 288

Customized PDS decors on request, see page 195

Profiles of 270 cm length: please order the base separately.

G/4/SF is a stair nosing profile of Unisystem Plus range, composed of a base and a top profile, for the floating installation of wooden and laminate floors with thicknesses from 6,5 to 15,5 mm.



G/4/SF aluminium covered with Alcrom® Plus film

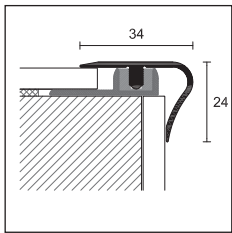

G/4/SF + TPU/

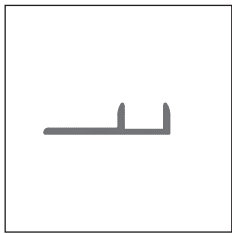

TPU/

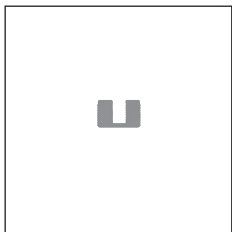

TU/6

UNISYSTEM PLUS

length = 270 cm - pack 10 pcs - for floor thicknesses from 6,5 to 15,5 mm

ART. finishing

ALUMINIUM covered with ALCROM® PLUS film

G/4/SF	02	63905	37	63943	76	63956
	08	63907	38	63919	77	63937
	10	63910	40	63920	78	63934
	11	63911	41	63926	79	63938
	12	63913	42	63921	80	63935
	13	63916	43	63927	81	63939
	18	63914	44	63929	92	63941
	20	63915	65	63931	93	63944
	32	63917	71	63951	94	63945
	34	63923	72	63952	95	63946
	35	63924	73	63953		
	36	63942	74	63954		
	euro/m			12,10		

individually packed

UNISYSTEM PLUS

length = 270 cm - pack 10 pcs - for floor thicknesses from 6,5 to 15,5 mm

ART. finishing

ANODISED ALUMINIUM

G/4/SF	silver		63900
	gold sand		63904
euro/m			7,18

individually packed - sand gold anodised extra euro/m + 0,63

UNISYSTEM PLUS - BASES

floor thickness from / to mm	6,5/10	9,6/12,5	12,6/15,5		
length = 270 cm pack 20 pcs (15 clips TU/6 included)	H				
ART. finishing	6	10	13		
ALUMINIUM					
TPU/ natural aluminium		67437	67447	67457	
euro/m			4,71	5,26	5,74

individually packed

SPARE CLIPS

pack da 150 pcs	H
	6
TU/6	68812/150
euro/pack	22,42

no partial packaging

For a single piece, see sales conditions on page 288

Profiles of 270 cm length: please order the base separately.

Customized PDS decors on request, see page 195

profix thin

Profix Thin is a system for the floating installation of LVT floors from 4 to 8 mm thickness, composed of junction profiles for same level floors (Z/4), connection profiles for different level floors (C/4) and perimetral profiles (S/4). The system is composed of a PVC base and a top profile available in different finishes of anodised aluminium or covered with wood-, stone- or concrete-effect Alcrom® Plus film for matching the floor perfectly.

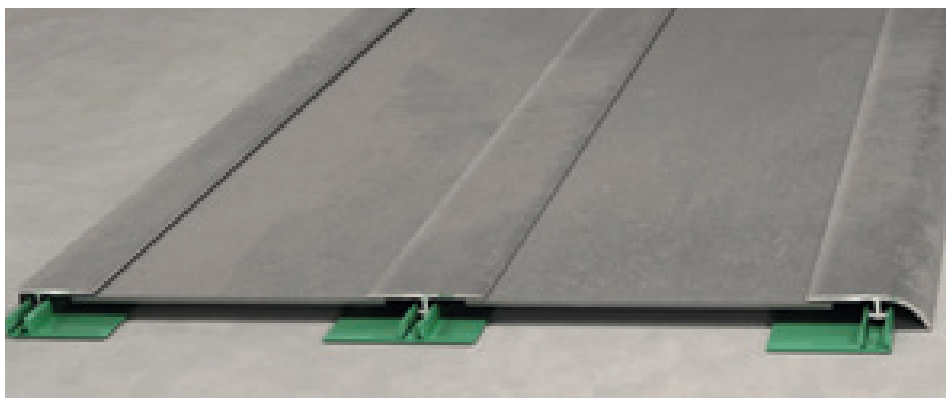

Profix Thin S/4, Z/4 and C/4

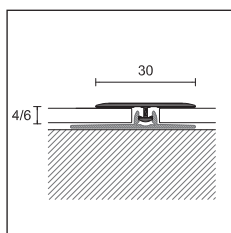

Z/4 + PT/4

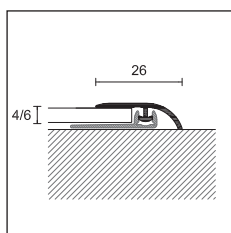

C/4 + PT/4/SA

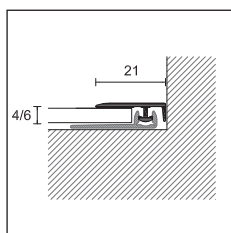

S/4 + PT/4/SA

PROFIX THIN

length = 270 cm - pack 20 pcs

for floor thickness (from 4 to 8 mm)

ALUMINIUM covered with ALCROM® PLUS film





	Z/4	C/4	S/4
1003	85101	85201	85301
1006	85102	85202	85302
1009	85103	85203	85303
1012	85104	85204	85304
1021	85107	85207	85307
1024	85108	85208	85308
1030	85110	85210	85310
1033	85111	85211	85311
1036	85112	85212	85312
1042	85114	85214	85314
1045	85115	85215	85315
1051	85117	85217	85317
1054	85118	85218	85318
1057	85119	85219	85319
1060	85120	85220	85320
1063	85121	85221	85321
1066	85122	85222	85322
1069	85123	85223	85323
1081	85127	85227	85327
1084	85128	85228	85328
1090	85130	85230	85330
1105	85135	85235	85335
1108	85136	85236	85336
1111	85137	85237	85337
euro/m	5,41	5,41	5,41

individually packed

PROFIX THIN

length = 270 cm - pack 20 pcs

for floor thickness (from 4 to 8 mm)

ART.	Z/4	C/4	S/4
finishing			
ANODISED ALUMINIUM			
silver	 85050	85060	85070
euro/m	3,23	3,23	3,23
gold sand	 85052	85062	85072
titanium	 85054	85064	85074
euro/m	3,59	3,59	3,59
bronze elox	 85056	85066	85076
euro/m	3,86	3,86	3,86

Customized PDS decors on request, see page 195

For a single piece, see sales conditions on page 288

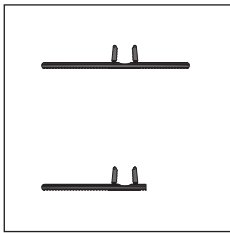

PT/4
PT/4/SA

PROFIX THIN - BASES

length = 270 cm - pack 20 pcs

for floor thickness (from 4 to 6 mm)

ART.	PT/4	PT/4/SA
finishing		
PVC		
green	 85081	85083
euro/m	1,54	1,53

To order PT/4 and PT/4/SA in pack of 100 pcs mark /100 after the article code (for example code 85081 becomes 85081/100). Pack of 100 pcs of PT/4 and PT/4/SA €/m **1,27**

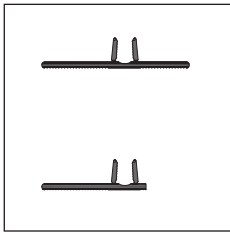

PT/6
PT/6/SA

PROFIX THIN - BASES

length = 270 cm - pack 20 pcs

for floor thickness (from 6 to 8 mm)

ART.	NEW PT/6	NEW PT/6/SA
finishing		
PVC		
green	 85086	85088
euro/m	1,54	1,53

To order PT/6 and PT/6/SA in pack of 100 pcs mark /100 after the article code (for example code 85086 becomes 85086/100). Pack of 100 pcs of PT/6 and PT/6/SA €/m **1,27**

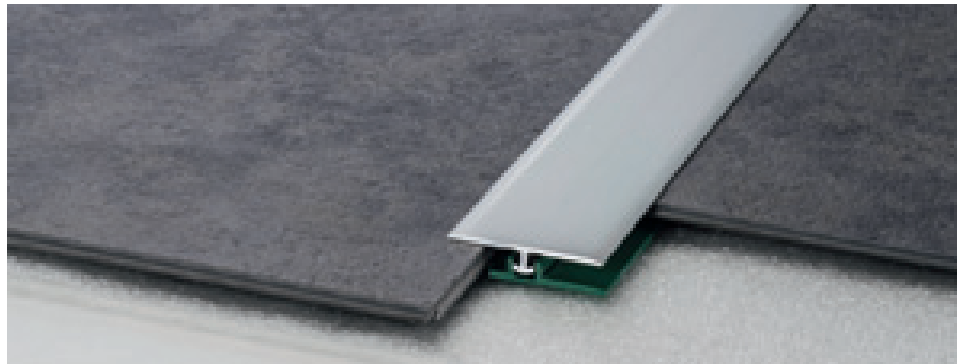

Z/4 + PT/4

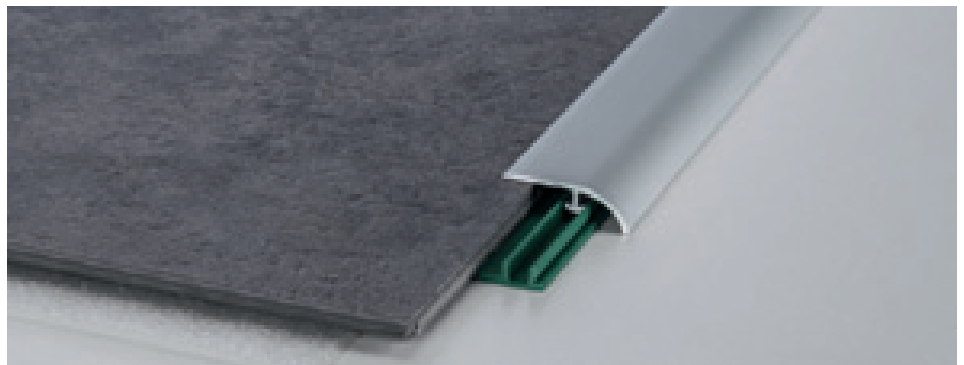

C/4 + PT/4/SA

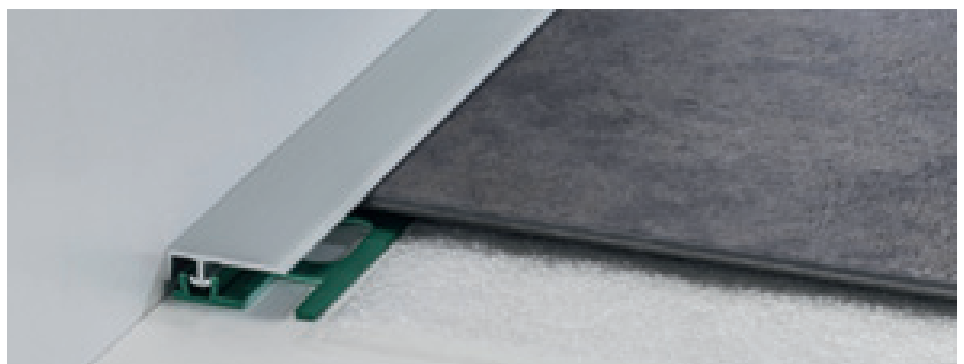

S/4 + PT/4/SA

prestowood

Prestowood 22/A, 50/A and 63/A are adhesive profiles for wooden floors of same level, different level and stairs that have been already installed. In anodised aluminium, or covered with Alcrom® Plus film, they are particularly easy and quick to install, thus becoming suitable also for the DIY.



22/A aluminium covered with Alcrom® Plus film

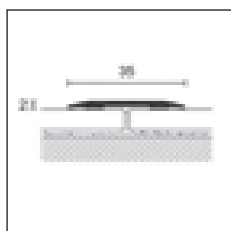

422/AD
22/A

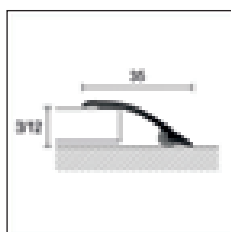

450/AD
50/A

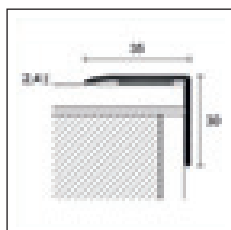

63/A



PRESTOWOOD

pack	10 pcs / blister	10 pcs	10 pcs / blister	10 pcs	10 pcs
length cm	90	270	90	270	270
ART.	422/AD	22/A	450/AD	50/A	63/A
ALUMINIUM covered with ALCROM® PLUS film					
05	43700	43932	44949	45031	45140
08	43701	43933	44950	45032	45141
12	43702	43934	44951	45033	45142
13	43703	43935	44952	45034	45143
14	43704	43936	44953	45035	45144
19	43705	43937	44954	45036	45145
26	43706	43938	44955	45037	45146
31	43707	43939	44956	45038	-
32	43708	43940	44957	45039	45147
34	43709	43941	44958	45040	-
36	43710	43942	44959	45041	45148
39	43711	43943	44960	45042	45149
40	43712	43944	44961	45043	45150
41	43713	43945	44962	45044	45151
73	43714	43946	44963	45045	-
74	43715	43947	44964	45046	-
77	43716	43948	44965	45047	45152
79	43717	43949	44966	45048	-
81	43718	43950	44967	45049	-
89	43719	43951	44968	45050	45153
91	43720	43952	44969	45051	45154
92	43721	43953	44970	45052	-
93	43762	43995	45013	45094	45155
94	43722	43954	44971	45053	-
351	43723	43955	44972	45054	-
363	43724	43956	44973	45055	-
372	43725	43957	44974	45056	-
490	43727	43959	44976	45058	-
560	43728	43960	44977	45059	-
580	43729	43961	44978	45060	45156
590	43730	43962	44979	45061	-
665	43731	43963	44980	45062	-
670	43732	43964	44981	45063	-
951	43738	43970	44987	45069	-
975	43739	43971	44988	45070	-
1024	43740	43972	44989	45071	-
1033	43741	43973	44990	45072	-
1042	43742	43974	44991	45073	-
1090	43744	43976	44993	45075	-

 packaging in blister no partial packaging

Customized PDS decors on request, see page 195

For a single piece, see sales conditions on page 288



pack	10 pcs / blister	10 pcs	10 pcs / blister	10 pcs	10 pcs	
length cm	90	270	90	270	270	
ART.	422/AD	22/A	450/AD	50/A	63/A	
ALUMINIUM covered with ALCROM® PLUS film						
	1202	43746	43978	44995	45077	45158
	1203	43747	43979	44996	45078	45159
	1204	43748	43980	44997	45079	45160
	1205	43749	43981	44998	45080	45161
	1206	43750	43982	44999	45081	45162
	1207	43751	43983	45000	45082	45163
	1208	43752	43984	45001	45083	45164
	1209	43753	43985	45002	45084	45165
	1210	43754	43986	45003	45085	45166
	1211	43755	43987	45004	45086	45167
	1212	43756	43988	45005	45087	45168
	1213	43757	43989	45007	45088	45169
	1214	43758	43990	45008	45089	45170
	1215	43759	43991	45009	45090	45171
	1216	43760	43992	45010	45091	45172
	1217	43761	43993	45011	45092	45173
	100	-	43994	-	45093	-
NEW	black 97	-	43996	-	45095	45175
euro/pc	8,74	-	8,74	-	-	-
euro/m	-	8,13	-	8,13	10,43	-

individually packed

PROCLASSIC F / PROLEVEL HIGH / PROTECT

pack	10 pcs / blister	10 pcs	10 pcs / blister	10 pcs	10 pcs	
length cm	90	270	90	270	270	
ART.	422/AD	22/A	450/AD	50/A	63/A	
ANODISED ALUMINIUM						
	silver	43790	44000	45019	45100	45190
euro/pc	6,43	-	6,43	-	-	
euro/m	-	5,58	-	5,58	7,64	
	titanium	43791	44001	45020	45101	45191
euro/pc	7,28	-	7,28	-	-	
euro/m	-	6,55	-	6,55	8,61	

individually packed



50/A titanium anodised aluminium



63/A silver anodised aluminium

prestowood

Prestowood 74/A is a line of stair nosing profiles covered with wood-effect Alcrom® Plus film, for the protection of already-laid wooden step edges. Available in adhesive version, they are particularly recommended for DIY installations.

74/ is also available in different finishes of anodised aluminium, as the stair nosing profiles 73/ and 58/.



74/A aluminium covered with Alcrom® Plus film

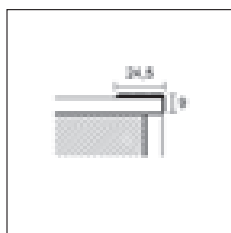

73/

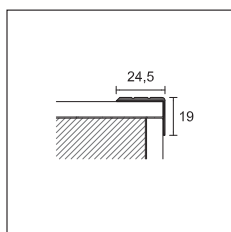

74/

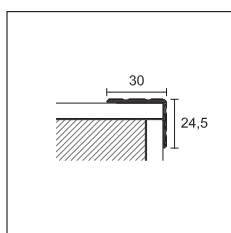

58/A

PRESTOWOOD

pack	10 pcs
length cm	270
ART.	74/A

finishing

ALUMINIUM covered with ALCROM® PLUS film

10	75319
12	75297
13	75301
20	75320
32	75303
36	75304
37	75305
38	75306
40	75322
47	75307
65	75294
71	75309
76	75334
78	75311
80	75326
92	75312
94	75313
95	75314

euro/m **10,29**

individually packed

PROTECT

pack	30 pcs						20 pcs
length cm	270						
ART.	73/			74/			58/
finishing	F	SF	A	F	SF	A	A
ALUMINIUM							
silver anodised	75208	75209	75238	75268	75269	75298	75900
gold anodised	75218	-	75248	75278	-	75308	-
bronze anodised	-	-	75258	-	-	75318	-
euro/m	3,84	3,69	5,06	4,41	4,26	5,63	6,25
titanium anodised						75299	
euro/m						7,15	

art. 73/ and 74/ gold anodised extra euro/m + **0,40**
 art. 73/ and 74/ bronze anodised extra euro/m + **0,80**

Customized PDS decors on request, see page 195

For a single piece, see sales conditions on page 288

RC is a line of edge profiles for the floating installation of wooden and laminate floors, available in different finishes of anodised aluminium or covered with wood-effect Alcrom® Plus film. This profile is also available in the bendable version RCF that can be curved with the specific Proflex Machine.

Prolevel High 732/ is a line of profiles for the protection of the perimetral border of wooden and laminate floors.



RC/9/F silver anodised aluminium



RC

length = 270 cm - pack 20 pcs

ART.	finishing	7	9	11	13	15
ALUMINIUM						
	silver anodised	67407	67477	67547	67617	67687
RC/ /F	gold anodised	-	67487	-	-	-
	bronze anodised	-	67497	-	-	-
euro/m		4,91	4,98	5,17	5,45	5,63

gold anodised extra euro/m + 0,40 - bronze anodised extra euro/m + 0,80

length = 270 cm - pack 10 pcs		H				
ART.	finishing	7	9	11	13	15
ALUMINIUM covered with ALCROM® PLUS film						
	10	-	66731	-	-	-
	20	-	66734	-	-	-
	38	-	66739	-	-	-
RC/ /F	40	-	66740	-	-	-
	42	-	66758	-	-	-
	65	-	66747	-	-	-
	78	-	66751	-	-	-
	80	-	66752	-	-	-
euro/m		-	6,98	-	-	-

RC

length = 90 cm - pack 10 pcs / blister

length = 90 cm - pack 10 pcs / blister		H			
ART.	finishing	7	9	11	15
ALUMINIUM					
	silver anodised	42782	41832	41877	42822
	gold anodised	-	41839	-	-
euro/pc		5,81	5,87	6,07	6,47

gold anodised extra euro/pc + 0,36

TERMINAL FLEX

length = 270 cm - pack 10 pcs

length = 270 cm - pack 10 pcs		H	
ART.	finishing	9	11
ALUMINIUM			
RCF/	silver anodised	67712	67714
euro/m		7,11	7,22

individually packed

PROLEVEL HIGH

length = 270 cm - pack 15 pcs

length = 270 cm - pack 15 pcs		H		
ART.	finishing	10	12,5	15
STAINLESS STEEL				
732/SF/	polished stainless steel AISI 430 DIN 1.4016	74217	74227	74237
euro/m		11,19	12,20	12,20

individually packed

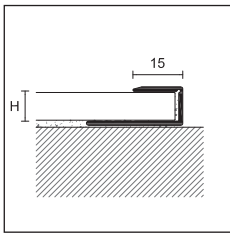

RC/ /F
RCF/



RCF/ silver anodised aluminium

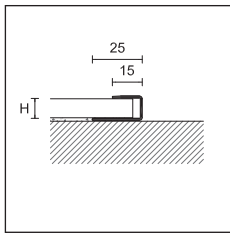

732/SF/

Complete the article code with H measure (for example RC/ /F for H = 9 becomes RC/9/F)

Customized PDS decors on request, see page 195

For a single piece, see sales conditions on page 288

alfix 616

Alfix 616 is a professional system for the laying of wooden and laminate floors with thickness from 6 to 16 mm. The system is composed of a top profile in anodised aluminium fixed with screws on a natural aluminium base. The screws, included in the packaging, have the same colour of the top profile in order to perfectly match it.



FIX/L/55 silver anodised aluminium

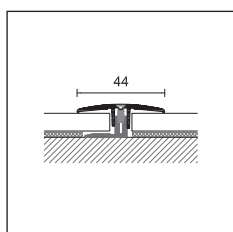

FIX/J/44



ALFIX 616





pack	10 pcs	10 pcs / blister 	
length cm	270	90	100

ART. **FIX/J/44**

for floor thicknesses from 6 to 16 mm

finishing

ALUMINIUM

silver anodised		37010	37012	37014
sand gold anodised		37210	37212	-
euro/m		15,27	-	-
euro/pc		-	14,71	16,26
titanium anodised		37410	-	37414
elox bronze anodised		37310	37312	37314
euro/m		15,98	-	-
euro/pc		-	15,37	16,95

individually packed

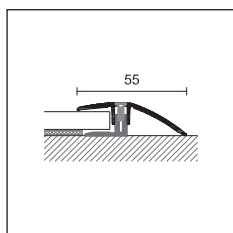

FIX/L/55

ALFIX 616





pack	10 pcs	10 pcs / blister 	
length cm	270	90	100

ART. **FIX/L/55**

for floor thicknesses from 6 to 16 mm

finishing

ALUMINIUM

silver anodised		37040	37042	37044
sand gold anodised		37240	37242	37244
euro/m		16,64	-	-
euro/pc		-	15,93	17,63
titanium anodised		37440	37442	37444
elox bronze anodised		37340	-	-
euro/m		17,37	-	-
euro/pc		-	16,49	18,33

individually packed

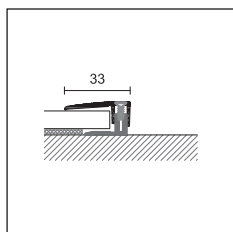

FIX/T/33

ALFIX 616





pack	10 pcs	10 pcs / blister 	
length cm	270	90	100

ART. **FIX/T/33**

for floor thicknesses from 6 to 16 mm

finishing

ALUMINIUM

silver anodised		37070	-	37074
sand gold anodised		37270	37272	-
euro/m		15,27	-	-
euro/pc		-	14,71	16,26
titanium anodised		37470	-	37474
elox bronze anodised		-	-	37374
euro/m		15,98	-	-
euro/pc		-	15,37	16,95

individually packed

For a single piece, see sales conditions on page 288

 packaging in blister no partial packaging

Alfix 46 is a professional system for the laying of LVT floors from 4 to 6 mm. This system is characterized by top profiles in anodised aluminium, fixed with a screw system on a natural aluminium base. Screws, included in the package, have the same colour of the anodisation and, once fixed, integrate with the top profile.



FIX/J/30 silver anodised aluminium



FIX/L/32 silver anodised aluminium



FIX/T/19 silver anodised aluminium

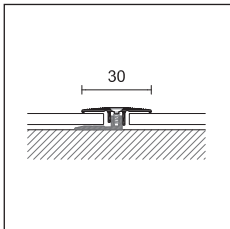

FIX/J/30

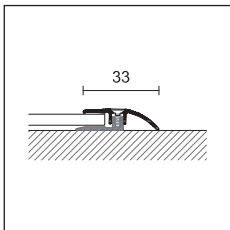

FIX/L/32

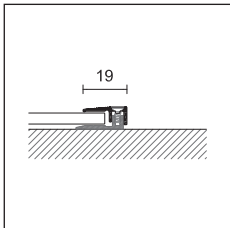

FIX/T/19

ALFIX 46

pack	10 pcs
length cm	270
ART.	FIX/J/30

for floor thicknesses from 4 to 6 mm

finishing

ALUMINIUM

silver anodised		35500
euro/m		15,33

individually packed

ALFIX 46

pack	10 pcs
length cm	270
ART.	FIX/L/32

for floor thicknesses from 4 to 6 mm

finishing

ALUMINIUM

silver anodised		35510
euro/m		15,33

individually packed

ALFIX 46

pack	10 pcs
length cm	270
ART.	FIX/T/19

for floor thicknesses from 4 to 6 mm

finishing

ALUMINIUM

silver anodised		35520
euro/m		15,33

individually packed

cerfix® projoint - pronivel

NZA/ is an expansion joint in aluminium composed of two interlocking and sliding profiles.

Suitable for LVT floors and tiles of small gaps, it guarantees a good resistance to loads and intense foot traffic. This item can be 3 mm high and, therefore, suitable for the application on substrate joints in glued LVT; it can also be 5 mm high and, in this case, thanks to the exclusive solution with the adhesive integrated with the internal anchor flange, it can be fixed directly to the board and it is the perfect joint for LVT floating floors with a uninterrupted surface and perfectly flat.



NZA/5A silver anodised aluminium

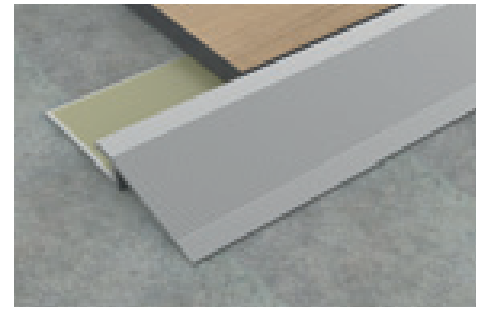

PBA/5A silver anodised aluminium

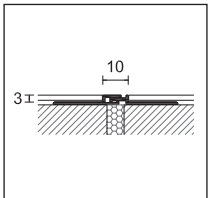

NZA/3

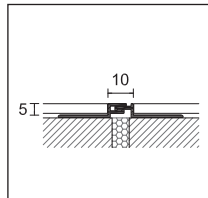

NZA/5

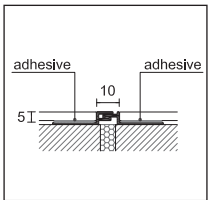

NZA/5A

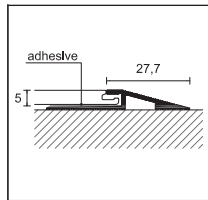

PBA/5A



PROJOINT

length = 270 cm - pack 20 pcs

ART.	finishing	3	5	5A
ALUMINIUM				
NZA/	silver anodised	99300	99320	99310
	euro/m	15,33	15,72	17,75
	titanium anodised	-	-	99314
	elox bronze anodised	-	-	99316
euro/m				18,55

individually packed

PRONIVEL

length = 270 cm - pack 10 pcs

ART.	finishing	5
ALUMINIUM		
PBA/5A	silver anodised	93205
euro/m		8,87

individually packed

NTA/ and NTI/ are expansion joints that are also ideal for glued LVT floors and that should be installed in line with the substrate joints.



NTA/3 natural aluminium + EPDM grey

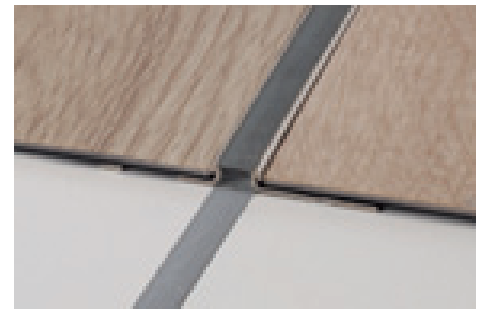

NTI/3 stainless steel + EPDM grey

PROJOINT DIL

length = 270 cm - pack 10 pcs

ART.	finishing	3
ALUMINIUM		
NTA/	natural aluminium + EPDM grey polishable RAL 7046	99421
	natural aluminium + EPDM black polishable RAL 9005	99422
	natural aluminium + EPDM bahama polishable RAL 10070	99427
	natural aluminium + EPDM brown polishable RAL 10071	99429
euro/m		21,35

PROJOINT DIL

length = 270 cm - pack 10 pcs

ART.	finishing	3
STAINLESS STEEL		
NTI/	stainless steel AISI 304 DIN 1.4301 + EPDM grey RAL 7046	99471
	stainless steel AISI 304 DIN 1.4301 + EPDM black RAL 9005	99472
	stainless steel AISI 304 DIN 1.4301 + EPDM bahama RAL 10070	99431
	stainless steel AISI 304 DIN 1.4301 + EPDM brown RAL 10071	99433
euro/m		32,84

H/5/F, PBAS/5/F, RC/5/F and 99/TR/26 are connection profiles in anodised aluminium, for floating LVT floors and suitable as profiles for same height, different height and for borders.

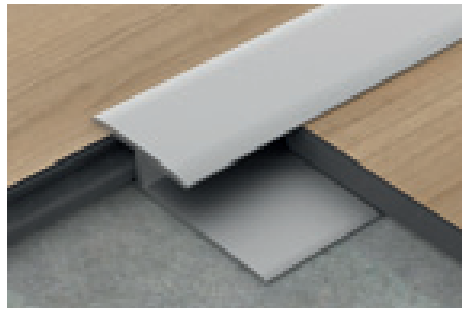

H/5/F silver anodised aluminium



PBAS/5/S silver anodised aluminium

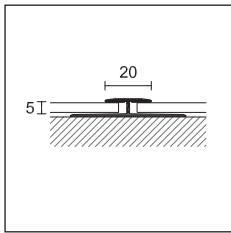

H/5/F

PROJOINT T

length = 270 cm - pack 20 pcs		H
ART.	finishing	5
ALUMINIUM		
H/5/F drilled	silver anodised	75000
	euro/m	7,13

individually packed

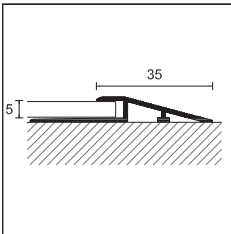

PBAS/5/F

PRONIVEL PB

length = 270 cm - pack 20 pcs		H
ART.	finishing	5
ALUMINIUM		
PBAS/5/F drilled	silver anodised	95203
	euro/m	7,13

individually packed

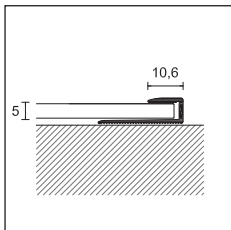

RC/5/F

RC

length = 270 cm - pack 20 pcs		H
ART.	finishing	5
ALUMINIUM		
RC/5/F drilled	silver anodised	67475
	euro/m	4,84

individually packed

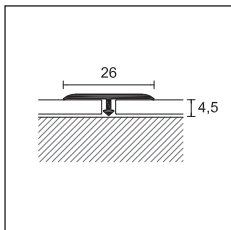

99/TR/26

PROJOINT T

length = 270 cm - pack 20 pcs		LxH
ART.	finishing	26 x 4,5
ALUMINIUM		
99/TR/26	silver anodised	75081
	euro/m	4,57

individually packed

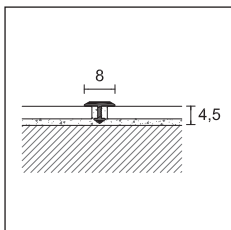

99/T/8

PROJOINT T - SEPARATION JOINTS

length = 270 cm - pack		50 pcs
width		8
ART.	finishing	
ALUMINIUM		
99/T/	silver anodised	75075
	euro/m	3,18
length = 270 cm - pack		50 pcs
BRASS		
399/T/	polished	75070
	euro/m	6,50
pack		30 pcs
399/TC/	chromium plated	75071
	euro/m	13,16

individually packed

prostep - protect

SMA/, 75/F, 111/ /F and G/705/F are profiles in anodised aluminium suitable for stairs covered with glued LVT. ZGF/ is a profile in aluminium suitable for following the curvilinear course of stairs or floors in glued LVT.



SMA/4 silver anodised aluminium

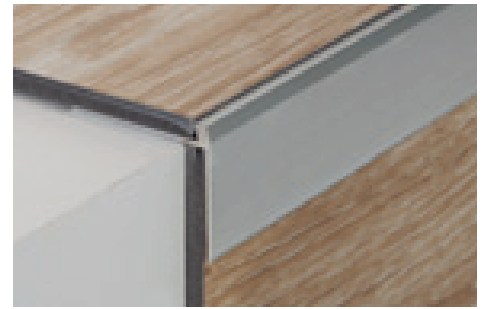

75/F silver anodised aluminium

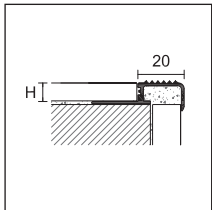

SMA/4



PROSTEP

length = 270 cm - pack 10 pcs

H

ART. finishing

4,5

ALUMINIUM

SMA/ natural aluminium

93967

euro/m

6,26

SMA/ silver anodised

93975

euro/m

7,52

individually packed

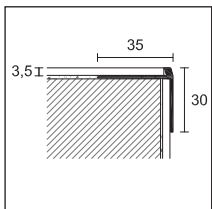

75/F



PROTECT

length = 340 cm - pack 20 pcs

H

ART. finishing

3,5

ALUMINIUM

75/F drilled silver anodised

75388

euro/m

6,45

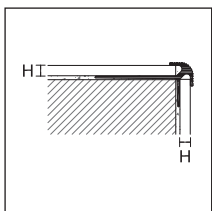

111/



PROTECT

length = 270 cm - pack 20 pcs

H

ART. finishing

2,5

4,5

5

ALUMINIUM

111/ /F silver anodised

75782

75784

75785

euro/m

6,77

7,13

7,38

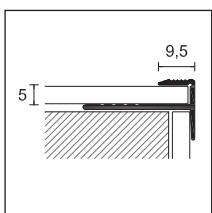

G/705/F



PROSTEP

length = 270 cm - pack 10 pcs

H

ART. finishing

5

ALUMINIUM

G/705/F silver anodised

67580

euro/m

7,39

individually packed

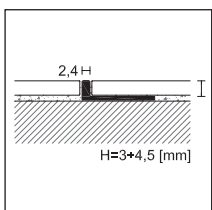

ZGF/

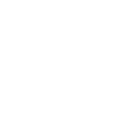

PROANGLE FLEX

length = 270 cm - pack 10 pcs

H

ART. finishing

4,5

ALUMINIUM

ZGF/ natural aluminium

88721

euro/m

3,13



111/2,5/F silver anodised aluminium



G/705/F silver anodised aluminium

For a single piece, see sales conditions on page 288

cerfix® protrim - proangle

RA/ and RI/ are profiles that are ideal for LVT coverings and are recommended as border profiles for floors or stairs finishing.

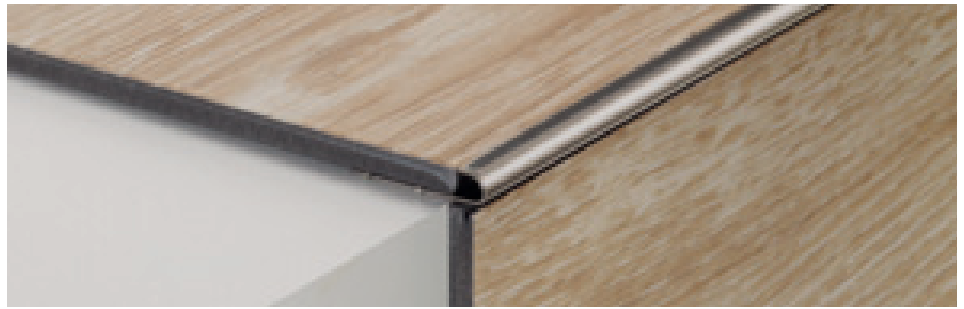

RI/4 stainless steel AISI 304 - DIN 1.4301

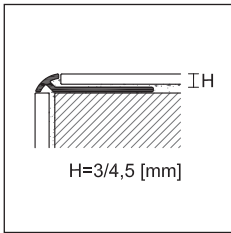

RA/



PROTRIM

length = 270 cm - pack 20 pcs

		H	
ART.	finishing	3	4,5
ALUMINIUM			
RA/	silver anodised	92055	92056
	gold anodised	92025	92026
	euro/m	3,77	3,98
	titanium anodised	92085	92086
	euro/m	4,40	4,61

individually packed

PROTRIM

length = 270 cm - pack 20 pcs

		H	
ART.	finishing	4,5	
STAINLESS STEEL			
RI/	stainless steel AISI 304 DIN 1.4301	92413	
	euro/m	8,27	

individually packed

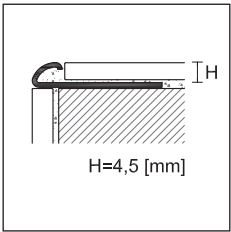

RI/

ZA/, AI/, ZQAN/, ZQKN/ and ZK/ are profiles suitable for LVT coverings and are recommended as connection and border profiles.

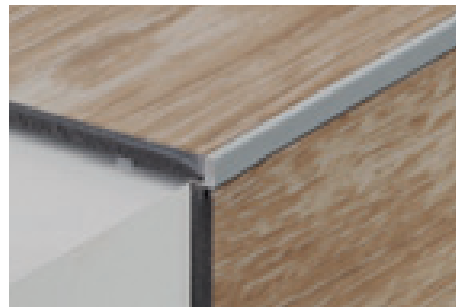

ZA/4 silver anodised aluminium

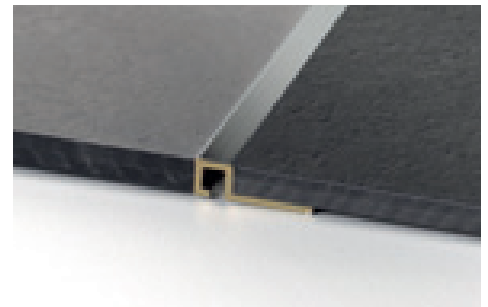

ZQKN/4 chromium-plated brass

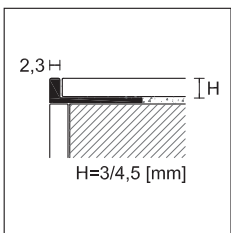

ZA/



PROANGLE

length = 270 cm - pack 20 pcs

		H		
ART.	finishing	2,5	3	4,5
ALUMINIUM				
ZA/	silver anodised	90337	90338	90340
	euro/m	2,95	2,95	3,08

STAINLESS STEEL

AI/	stainless steel AISI 304 DIN 1.4301	-	91636	91638
	euro/m	-	6,98	7,11

individually packed - version chromium - plated brass article ZK/3 and ZK/4,5 see page 29

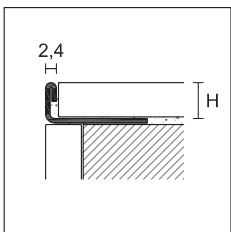

AI/



PROANGLE Q

length = 270 cm - pack 20 pcs

		H	
ART.	finishing	4,5	
ALUMINIUM			
ZQAN/	silver anodised	88772	
	euro/m	4,53	
ZQKN/	titanium anodised	88902	
	euro/m	5,16	

BRASS

ZQKN/	chromium plated	88870	
	euro/m	16,33	

individually packed

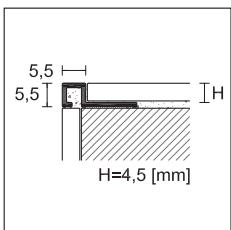

ZQAN/
ZQKN/

For a single piece, see sales conditions on page 288

cerfix® proround

GA/, JGA/ and PIA/ are connection profiles for stairs in glued LVT. Easy to lay, they facilitate the hygienic maintenance of the connection between tread and riser.

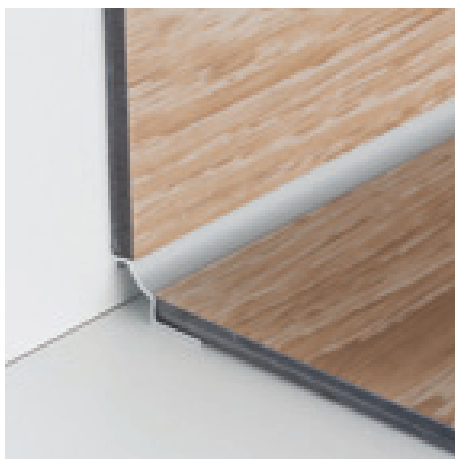

GA/4 silver anodised aluminium



JGA/4 silver anodised aluminium

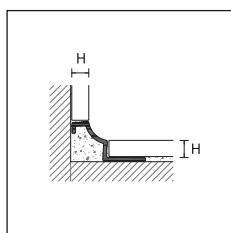

GA/



PROROUND M

length = 270 cm - pack 20 pcs

ART.	finishing		4,5
ALUMINIUM			
GA/	silver anodised		95730
	euro/m		7,36

individually packed

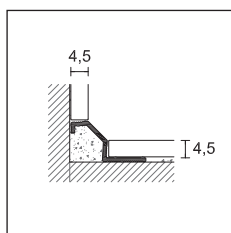

JGA/

PROROUND M

length = 270 cm - pack 20 pcs

ART.	finishing		4,5
ALUMINIUM			
JGA/	silver anodised		95732
	euro/m		7,36

individually packed

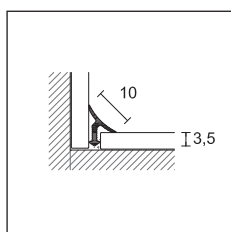

PIA/



PROINT

length = 270 cm - pack 20 pcs

ART.	finishing		3,5
ALUMINIUM			
PIA/	silver anodised		95431
	euro/m		4,99

individually packed



PIA/3 silver anodised aluminium

For a single piece, see sales conditions on page 288

PVC Line skirting boards for wooden, laminate and LVT floors



PVC Line 8605 covered with Alcrom® Plus film, see page 216



PVC Line 8608 covered with Alcrom® Plus film, see page 217



PVC Line 8615 covered with Alcrom® Plus film, see page 218



PVC Line 8613 covered with Alcrom® Plus film, see page 219



PVC Line 8612 covered with Alcrom® Plus film, see page 220



PVC Line 8614 covered with Alcrom® Plus film, see page 220

Profilpas Digital System no limits to imagination



Profilpas gives the possibility to choose between over 400 standard decors Alcrom® Plus to combine the chosen profile or skirting board with the floor perfectly: indeed, a wide selection of wood, stone or concrete decors is available in our database to meet every need. Just consult our PDS bunch to discover the decor that best suits to your wish of combination.

But that's not all. The possibility of customization is really limitless with Profilpas. We just need to

receive a sample for creating any further decor, even a fantasy one!

This is possible thanks to Profilpas Digital System (PDS), the innovative digital printing technology of Profilpas to reproduce any decor on Alcrom Plus film and not to give limits to imagination! The whole production process is made inside our factory: from the scanner to the printing and the application of the film.

Please note: for customizations with decors that are not in our database, there is an extra of 165 € for decor.

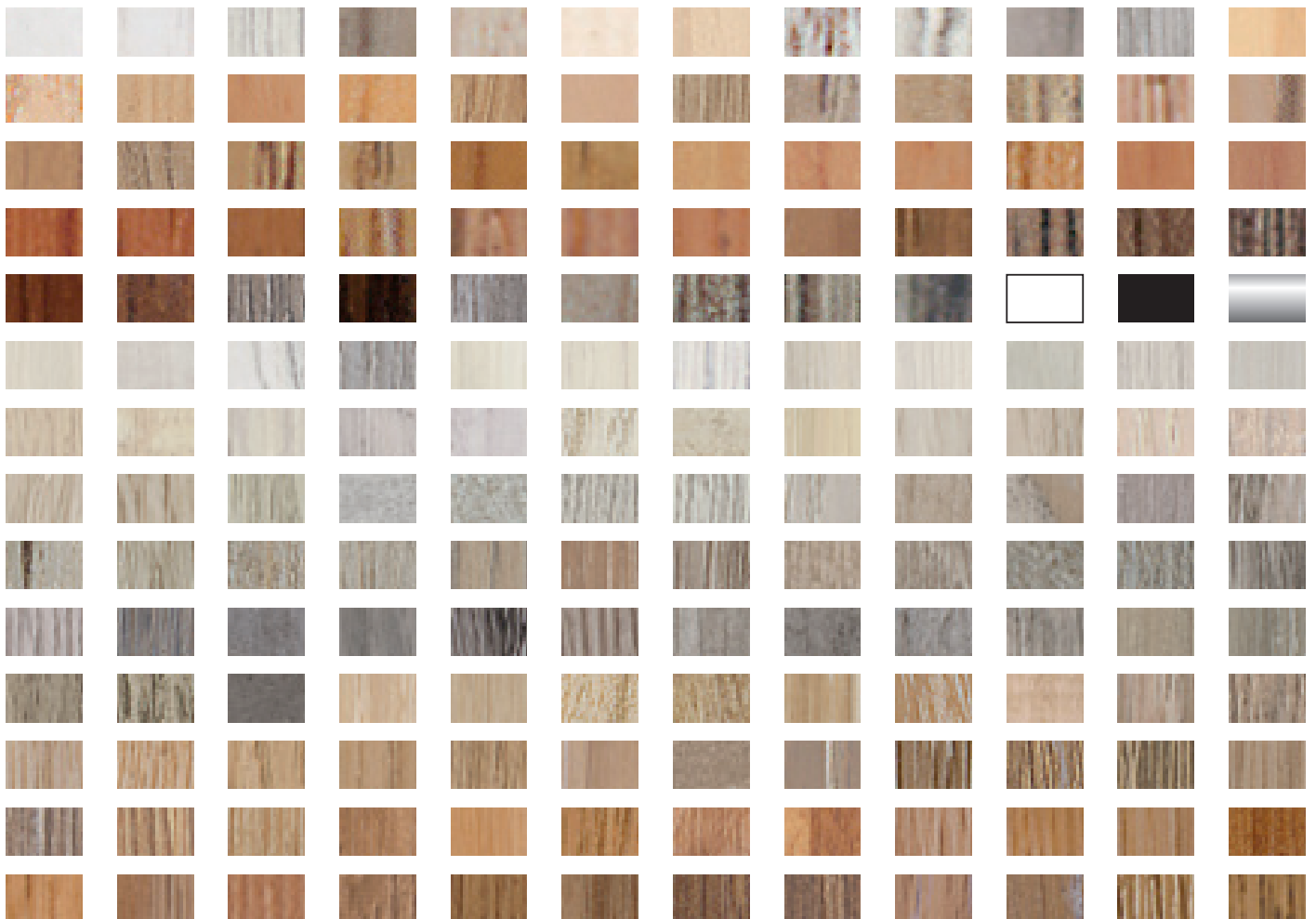



**UNISYSTEM PLUS Z/1, C/7, S/9
PROFIX THIN Z/4, C/4 AND S/4**

Quantity 20 pcs / 54 m = + 4,93 €/m

Quantity 40 pcs / 108 m = + 4,44 €/m

Quantity 60 pcs / 162 m = + 3,96 €/m

Quantity 80 pcs / 216 m = + 3,45 €/m

Quantity 100 pcs / 270 m = + 2,95 €/m

min. 54 m

Quantity 120 pcs / 324 m = + 2,45 €/m

Quantity 140 pcs / 378 m = + 1,98 €/m

Quantity 160 pcs / 432 m = + 1,47 €/m

Quantity 180 pcs / 486 m = + 0,98 €/m

Quantity 200 pcs / 540 m = + 0,00 €/m

Z3/30, C/10, C/13, C/22 E S/15

min. 540 m divisible into 5 decors

UNISYSTEM PLUS G/2 AND G/4

min. 540 m divisible into 5 decors

22/A, 50/A AND 63/A

min. 540 m divisible into 5 decors

74/A

min. 540 m divisible into 5 decors

RC/ /F

min. 540 m divisible into 5 decors

PVC LINE 8605, 8606, 8608, 8615, 8616, 8612, 8613 AND 8614

min. 540 m divisible into 2 decors

For the customization of other articles, please contact our Sales Department.

Please note: for customizations with decors that are not in our database, there is an extra of 165 € for decor.



WOOD,
LAMINATE, LVT